

**Product number FA11116_LXP-O-90**

Family	Leila	FWHM	(simulated) 9+43
Type	Assembly	Efficiency	(simulated) 92 %
LED	XP-E	cd/lm	(simulated) 6.500
Color	Black	Gerber File	Available
Diameter	21.6 mm		
Height	14.7 mm		
Style	Round		
Optic Material	PMMA		
Holder Material	-		
Fastening	["tape"]		
Status	Production ready		

**Product number CA11481_LXP2-RS**

Family	Leila	FWHM	7 degrees
Type	Assembly	Efficiency	94 %
LED	XP-E	cd/lm	-
Color	Black	Gerber File	Available
Diameter	21.6 mm		
Height	14.7 mm		
Style	Round		
Optic Material	PMMA		
Holder Material	-		
Fastening	["tape"]		
Status	Production ready		

**Product number CP11631_LXP3-RS**

Family	Leila	FWHM	7 degrees
Type	Assembly	Efficiency	94 %
LED	XP-E	cd/lm	36.000
Color	White	Gerber File	Available
Diameter	21.6 mm		
Height	14.7 mm		
Style	Round		
Optic Material	PMMA		
Holder Material	-		
Fastening	["glue"]		
Status	Production ready		

Suitable for Star PCB

**Product number CA14505_G2-LXP2-RS2-P**

Family	Leila	FWHM	7.0 degrees
Type	Assembly	Efficiency	88 %
LED	XP-E	cd/lm	34.650
Color	Black	Gerber File	Available
Diameter	21.8 mm		
Height	14.7 mm		
Style	Round		
Optic Material	PMMA		
Holder Material	-		
Fastening	["pin", "tape"]		
Status	Production ready		

**Product number CA14506_G2-LXP2-RS2**

Family	Leila	FWHM	7.0 degrees
Type	Assembly	Efficiency	88 %
LED	XP-E	cd/lm	34.650
Color	Black	Gerber File	Available
Diameter	21.8 mm		
Height	14.7 mm		
Style	Round		
Optic Material	PMMA		
Holder Material	-		
Fastening	["tape"]		
Status	Production ready		

Product number FA10661_LXP-RS

Family	Leila	FWHM	7.5 degrees
Type	Assembly	Efficiency	92 %
LED	XP-E	cd/lm	39.700
Color	Black	Gerber File	Available
Diameter	21.6 mm		
Height	14.7 mm		
Style	Round		
Optic Material	PMMA		
Holder Material	-		
Fastening	["tape"]		
Status	Production ready		

Product number CA11484_LXP2-O-90

Family	Leila	FWHM	9+41 degrees
Type	Assembly	Efficiency	89 %
LED	XP-E	cd/lm	5.800
Color	Black	Gerber File	Available
Diameter	21.6 mm		
Height	14.7 mm		
Style	Round		
Optic Material	PMMA		
Holder Material	-		
Fastening	["tape"]		
Status	Production ready		

Product number CP11634_LXP3-O-90

Family	Leila	FWHM	9+41 degrees
Type	Assembly	Efficiency	93 %
LED	XP-E	cd/lm	5.800
Color	White	Gerber File	Available
Diameter	21.6 mm		
Height	14.7 mm		
Style	Round		
Optic Material	PMMA		
Holder Material	-		
Fastening	["glue"]		
Status	Production ready		

**Product number FA11739_LXP-RS2**

Family	Leila	FWHM	9 degrees
Type	Assembly	Efficiency	94 %
LED	XP-E	cd/lm	25.000
Color	Black	Gerber File	Available
Diameter	21.6 mm		
Height	14.7 mm		
Style	Round		
Optic Material	-		
Holder Material	-		
Fastening	["tape"]		
Status	Production ready		

**Product number CA14507_G2-LXP2-D-P**

Family	Leila	FWHM	9.7 degrees
Type	Assembly	Efficiency	88 %
LED	XP-E	cd/lm	19.850
Color	Black	Gerber File	Available
Diameter	21.8 mm		
Height	14.7 mm		
Style	Round		
Optic Material	-		
Holder Material	-		
Fastening	["tape", "pin"]		
Status	Production ready		

**Product number CA14508_G2-LXP2-D**

Family	Leila	FWHM	9.7 degrees
Type	Assembly	Efficiency	88 %
LED	XP-E	cd/lm	19.850
Color	Black	Gerber File	Available
Diameter	21.8 mm		
Height	14.7 mm		
Style	Round		
Optic Material	-		
Holder Material	-		
Fastening	["tape"]		
Status	Production ready		

**Product number FA10663_LXP-D**

Family	Leila	FWHM	12 degrees
Type	Assembly	Efficiency	90 %
LED	XP-E	cd/lm	12.000
Color	Black	Gerber File	Available
Diameter	21.6 mm		
Height	14.7 mm		
Style	Round		
Optic Material	PMMA		
Holder Material	-		
Fastening	["tape"]		
Status	Production ready		

**Product number CP11632_LXP3-D**

Family	Leila	FWHM	13 degrees
Type	Assembly	Efficiency	94 %
LED	XP-E	cd/lm	-
Color	White	Gerber File	Available
Diameter	21.6 mm	Suitable for Star PCB	
Height	14.7 mm		
Style	Round		
Optic Material	PMMA		
Holder Material	-		
Fastening	["glue"]		
Status	Production ready		

**Product number CA11482_LXP2-D**

Family	Leila	FWHM	14 degrees
Type	Assembly	Efficiency	92 %
LED	XP-E	cd/lm	-
Color	Black	Gerber File	Available
Diameter	21.6 mm		
Height	14.7 mm		
Style	Round		
Optic Material	PMMA		
Holder Material	-		
Fastening	["tape"]		
Status	Production ready		

**Product number FA10660_LXP-M**

Family	Leila	FWHM	22 degrees
Type	Assembly	Efficiency	90 %
LED	XP-E	cd/lm	4.800
Color	Black	Gerber File	Available
Diameter	21.6 mm		
Height	14.7 mm		
Style	Round		
Optic Material	PMMA		
Holder Material	-		
Fastening	["tape"]		
Status	Production ready		

**Product number CA14509_G2-LXP2-M-P**

Family	Leila	FWHM	22 degrees
Type	Assembly	Efficiency	88 %
LED	XP-E	cd/lm	5.170
Color	Black	Gerber File	Available
Diameter	21.8 mm		
Height	14.7 mm		
Style	Round		
Optic Material	-		
Holder Material	-		
Fastening	["tape", "pin"]		
Status	Production ready		

Product number CA14510_G2-LXP2-M

Family	Leila	FWHM	22 degrees
Type	Assembly	Efficiency	88 %
LED	XP-E	cd/lm	5.170
Color	Black	Gerber File	Available
Diameter	21.8 mm		
Height	14.7 mm		
Style	Round		
Optic Material	-		
Holder Material	-		
Fastening	["tape"]		
Status	Production ready		

Product number CA11483_LXP2-M

Family	Leila	FWHM	23 degrees
Type	Assembly	Efficiency	94 %
LED	XP-E	cd/lm	4.600
Color	Black	Gerber File	Available
Diameter	21.6 mm		
Height	14.7 mm		
Style	Round		
Optic Material	PMMA		
Holder Material	-		
Fastening	["tape"]		
Status	Production ready		

Product number CP11633_LXP3-M

Family	Leila	FWHM	24 degrees
Type	Assembly	Efficiency	94 %
LED	XP-E	cd/lm	-
Color	White	Gerber File	Available
Diameter	21.6 mm		
Height	14.7 mm		
Style	Round		
Optic Material	PMMA		
Holder Material	-		
Fastening	["glue"]		
Status	Production ready		

Suitable for Star PCB

Product number FA11450_LXP-M2

Family	Leila	FWHM	25 degrees
Type	Assembly	Efficiency	91 %
LED	XP-E	cd/lm	3.700
Color	Black	Gerber File	Available
Diameter	21.6 mm		
Height	14.7 mm		
Style	Round		
Optic Material	-		
Holder Material	-		
Fastening	["tape"]		
Status	Production ready		

**Product number FA12218_LXP-O**

Family	Leila	FWHM	34+13 degrees
Type	Assembly	Efficiency	89 %
LED	XP-E	cd/lm	5.400
Color	Black	Gerber File	Available
Diameter	21.6 mm		
Height	14.7 mm		
Style	Round		
Optic Material	-		
Holder Material	-		
Fastening	["tape"]		
Status	Production ready		

**Product number FA10662_LXP-REC**

Family	Leila	FWHM	40+22 degrees
Type	Assembly	Efficiency	82 %
LED	XP-E	cd/lm	2.200
Color	Black	Gerber File	Available
Diameter	21.6 mm		
Height	14.7 mm		
Style	Round		
Optic Material	PMMA		
Holder Material	-		
Fastening	["tape"]		
Status	Production ready		

**Product number FA11116_LXP-O-90**

Family	Leila	FWHM	41+10 degrees
Type	Assembly	Efficiency	89 %
LED	XP-E	cd/lm	5.300
Color	Black	Gerber File	Available
Diameter	21.6 mm		
Height	14.7 mm		
Style	Round		
Optic Material	PMMA		
Holder Material	-		
Fastening	["tape"]		
Status	Production ready		

**Product number CP12395_LXP3-W**

Family	Leila	FWHM	42 degrees
Type	Assembly	Efficiency	92 %
LED	XP-E	cd/lm	1.800
Color	White	Gerber File	Available
Diameter	21.6 mm		
Height	14.7 mm		
Style	Round		
Optic Material	PMMA		
Holder Material	-		
Fastening	["glue"]		
Status	Production ready		

Star PCB compatible.

PRODUCT DATASHEET

Leila series

last update 10/4/2014

**Product number FA10832_LXP-W**

Family	Leila	FWHM	44 degrees
Type	Assembly	Efficiency	91 %
LED	XP-E	cd/lm	1.800
Color	Black	Gerber File	Available
Diameter	21.6 mm		
Height	14.7 mm		
Style	Round		
Optic Material	PMMA		
Holder Material	-		
Fastening	["tape"]		
Status	Production ready		

Product number CA12392_LXP2-W

Family	Leila	FWHM	48 degrees
Type	Assembly	Efficiency	90 %
LED	XP-E	cd/lm	1.700
Color	Black	Gerber File	Available
Diameter	21.6 mm		
Height	14.7 mm		
Style	Round		
Optic Material	PMMA		
Holder Material	-		
Fastening	["tape"]		
Status	Production ready		

NOTE: The typical divergence will be changed by different color, chip size and chip position tolerance. The typical total divergence is the full angle measured where the luminous intensity is half of the peak value.



PRODUCT DATASHEET

Leila series

last update 10/4/2014

GENERAL INFORMATION

- Product series especially designed & optimized for XP-E series of LEDs.
- Special care taken to make light distribution as uniform as possible.
- Lens material optical grade PMMA with high UV and temperature resistance. Allows use of high current and temperature conditions.

Please find more information about used material from below:

http://ledil.fi/sites/default/files/Documents/Technical/Material/PMMA%20N%20UL94_Yellow%20Card.pdf

<http://ledil.fi/sites/default/files/Documents/Technical/Material/PMMA%20N%20PLEXIGLAS-Datasheet.pdf>

Relative intensity of CA14505_G2-LXP2-RS2-P_(XP-E)

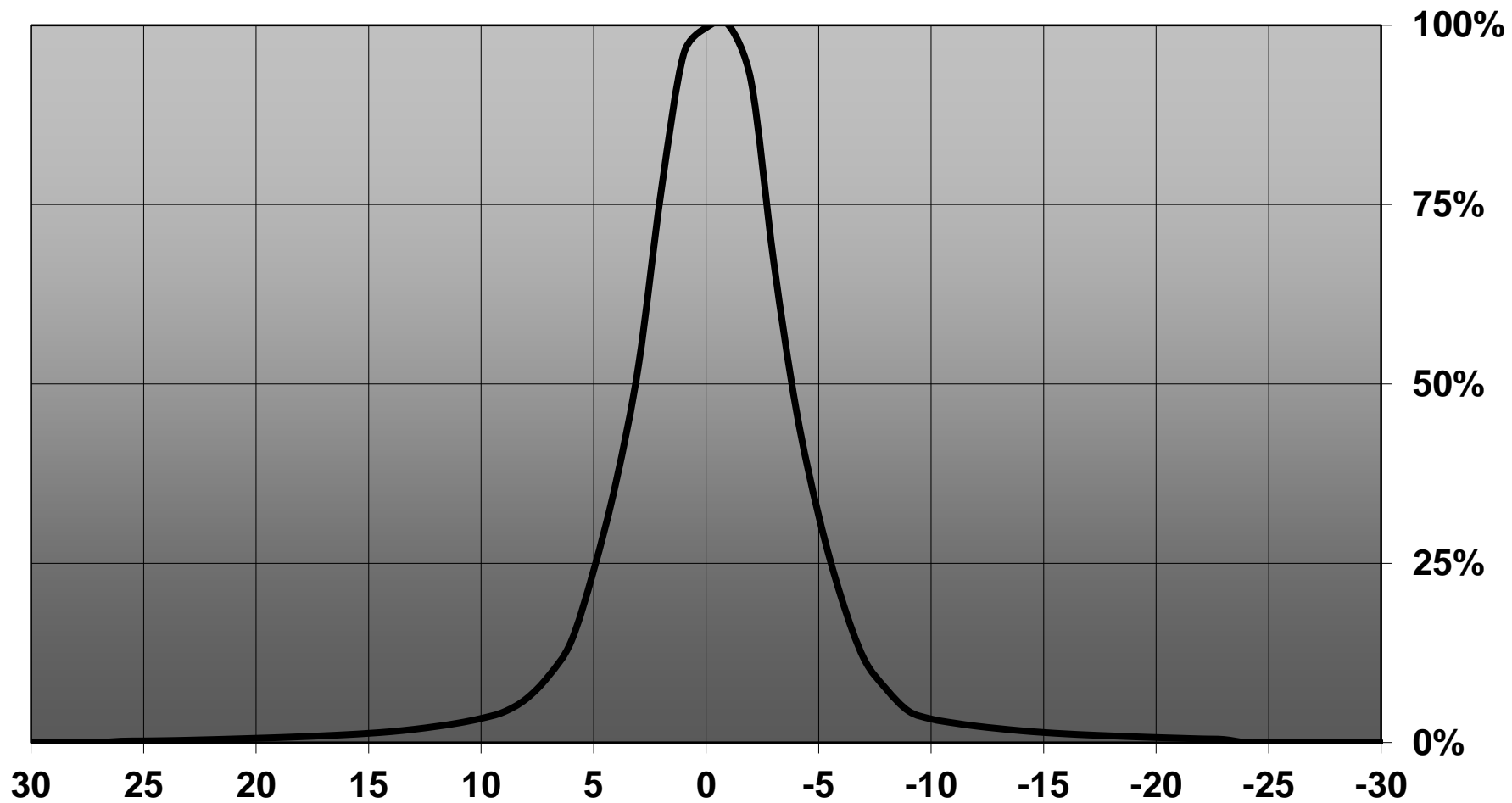

Relative intensity of CA14506_G2-LXP2-RS2_(XP-E)

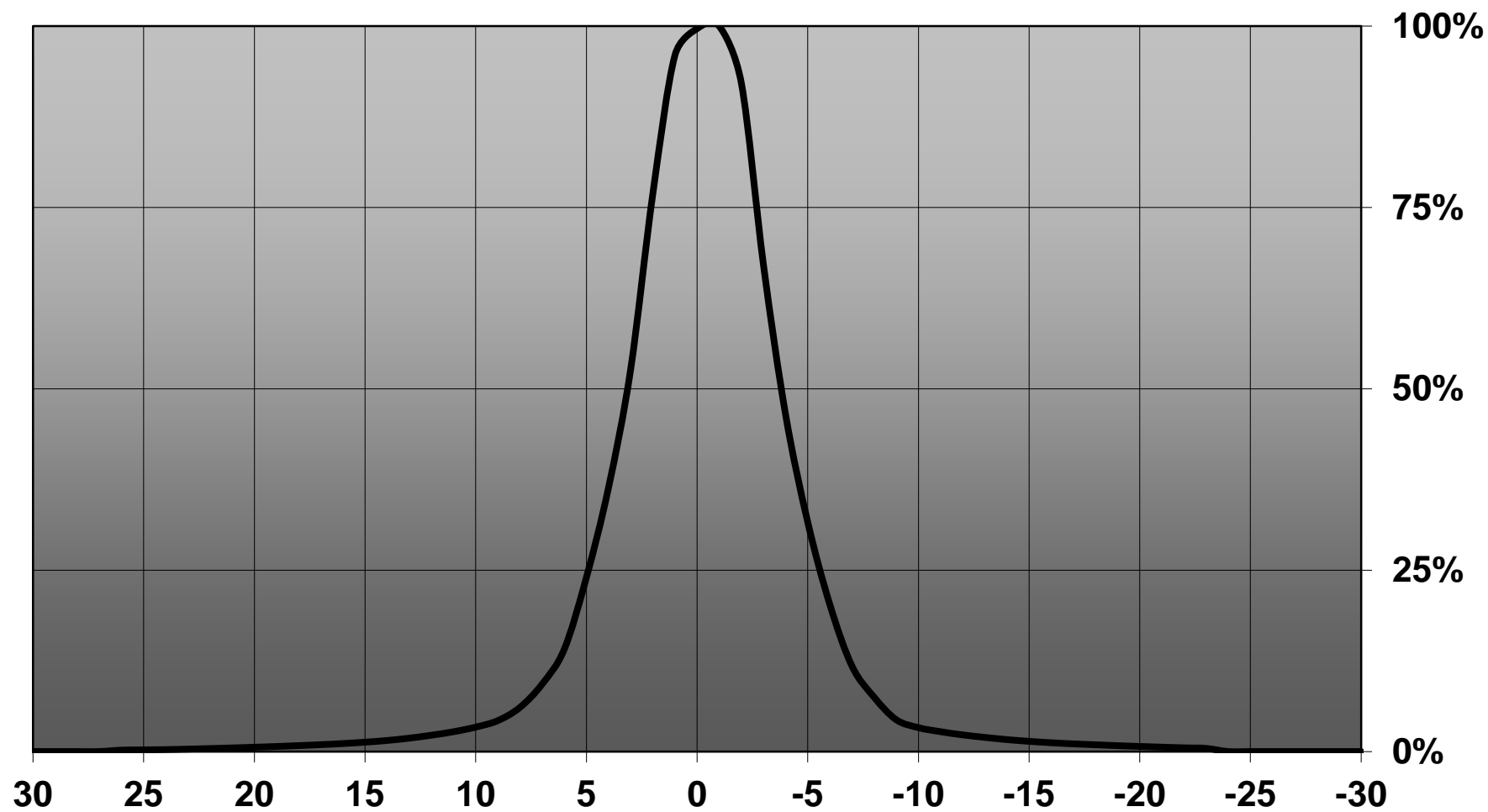

Relative intensity of CA14507_G2-LXP2-D-P_(XP-E)

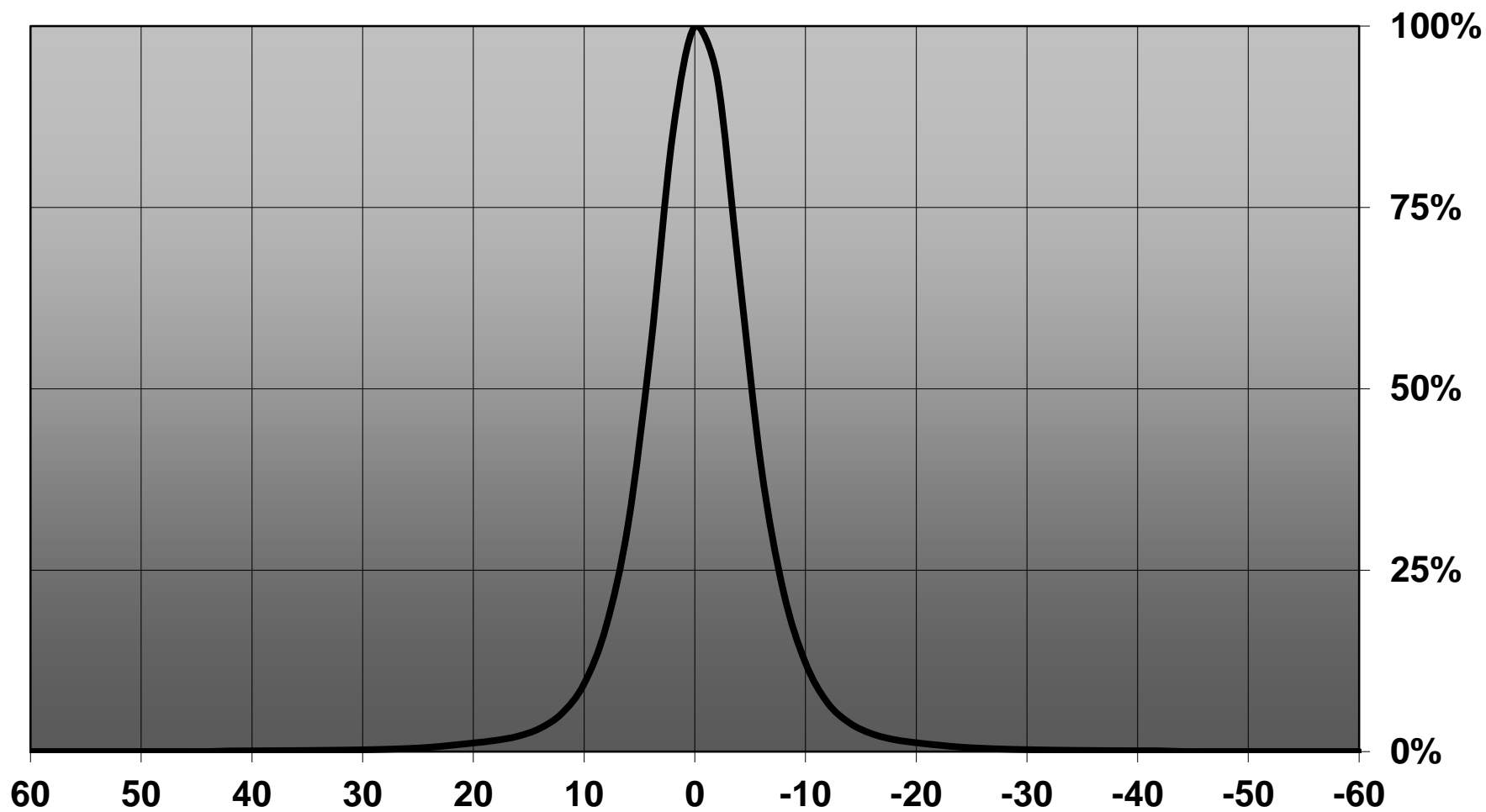

Relative intensity of CA14508_G2-LXP2-D_(XP-E)

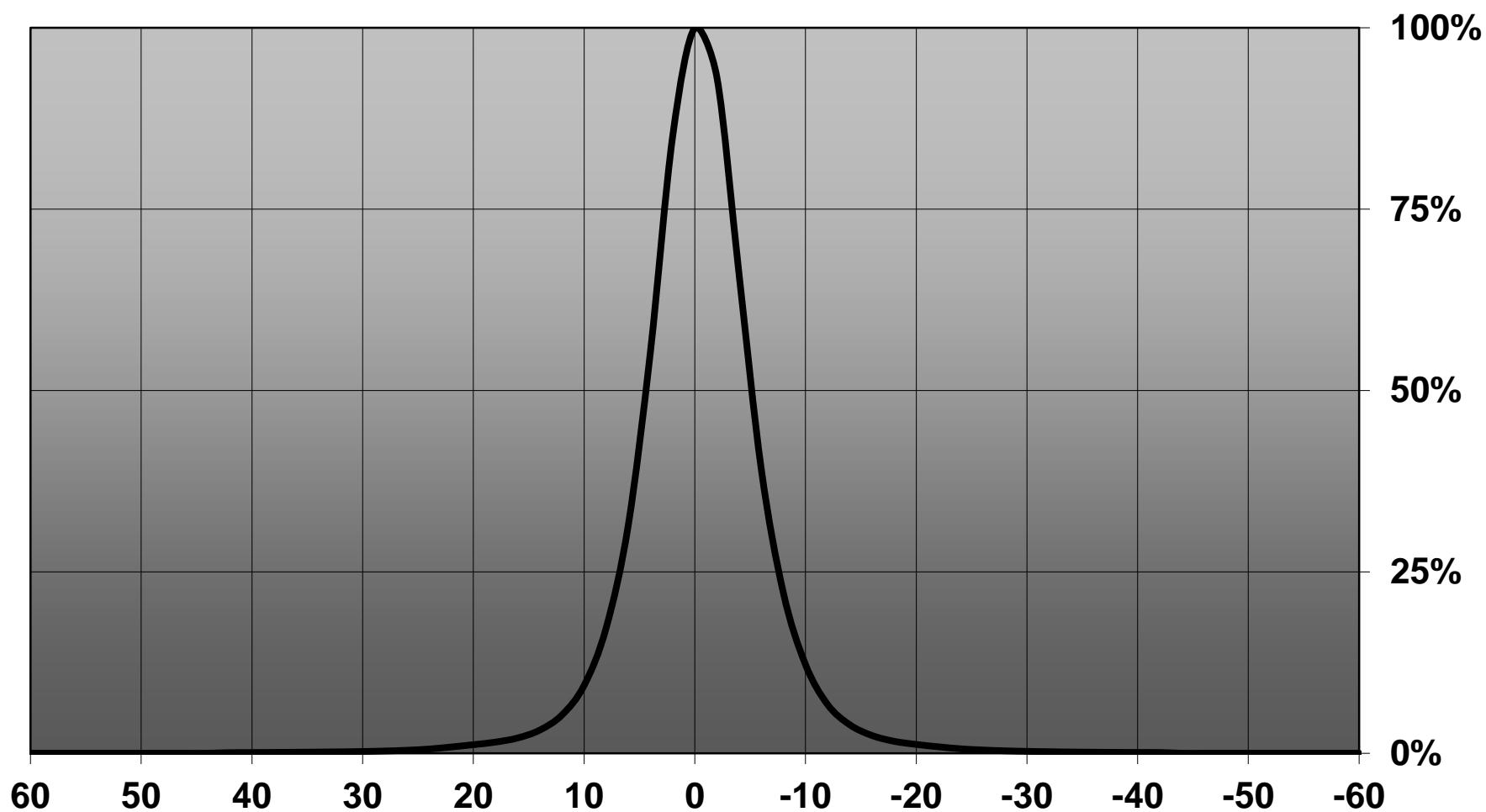

Relative intensity of CA14509_G2-LXP2-M-P_(XP-E)

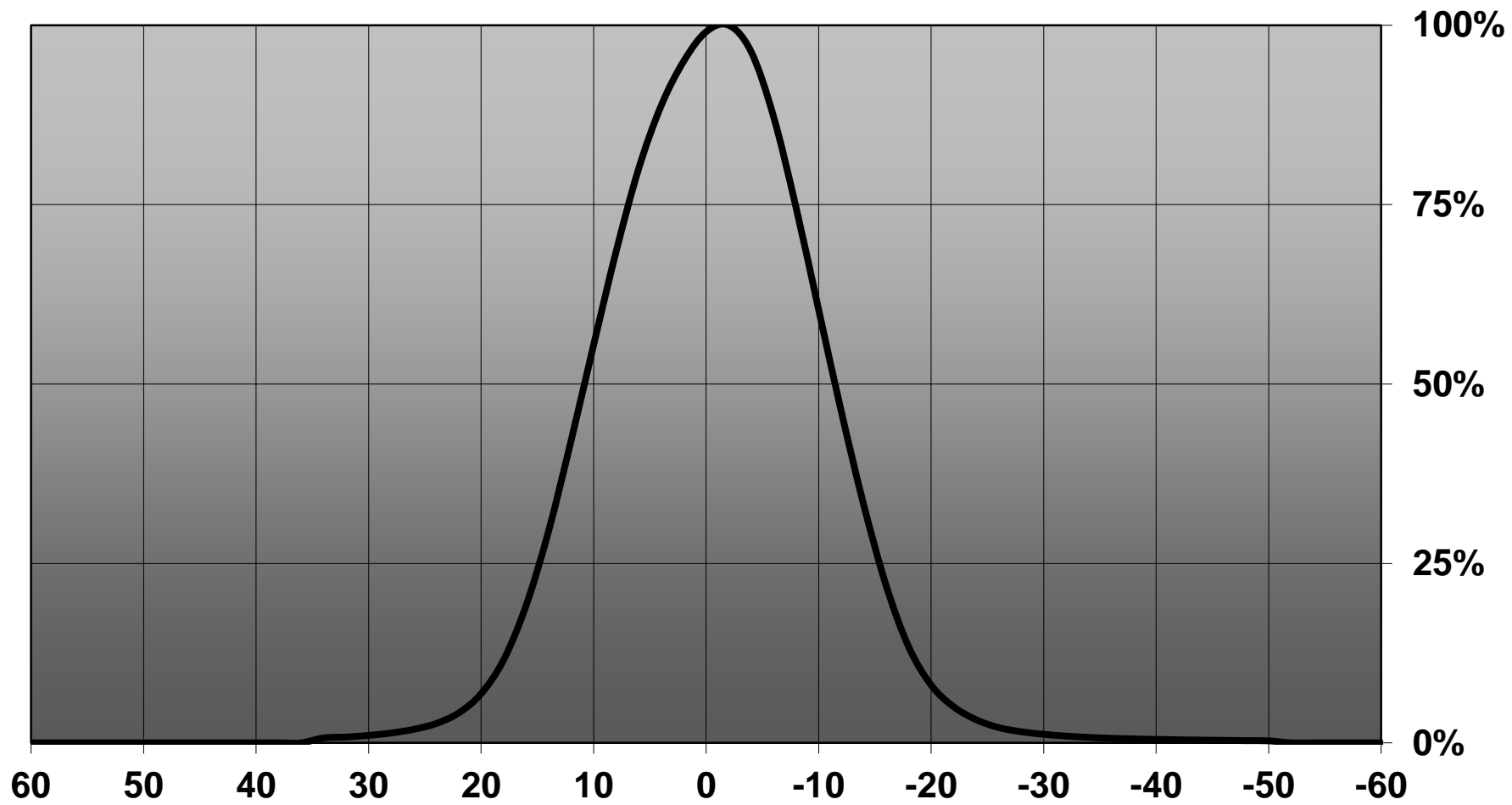

Relative intensity of CA14510_G2-LXP2-M_(XP-E)

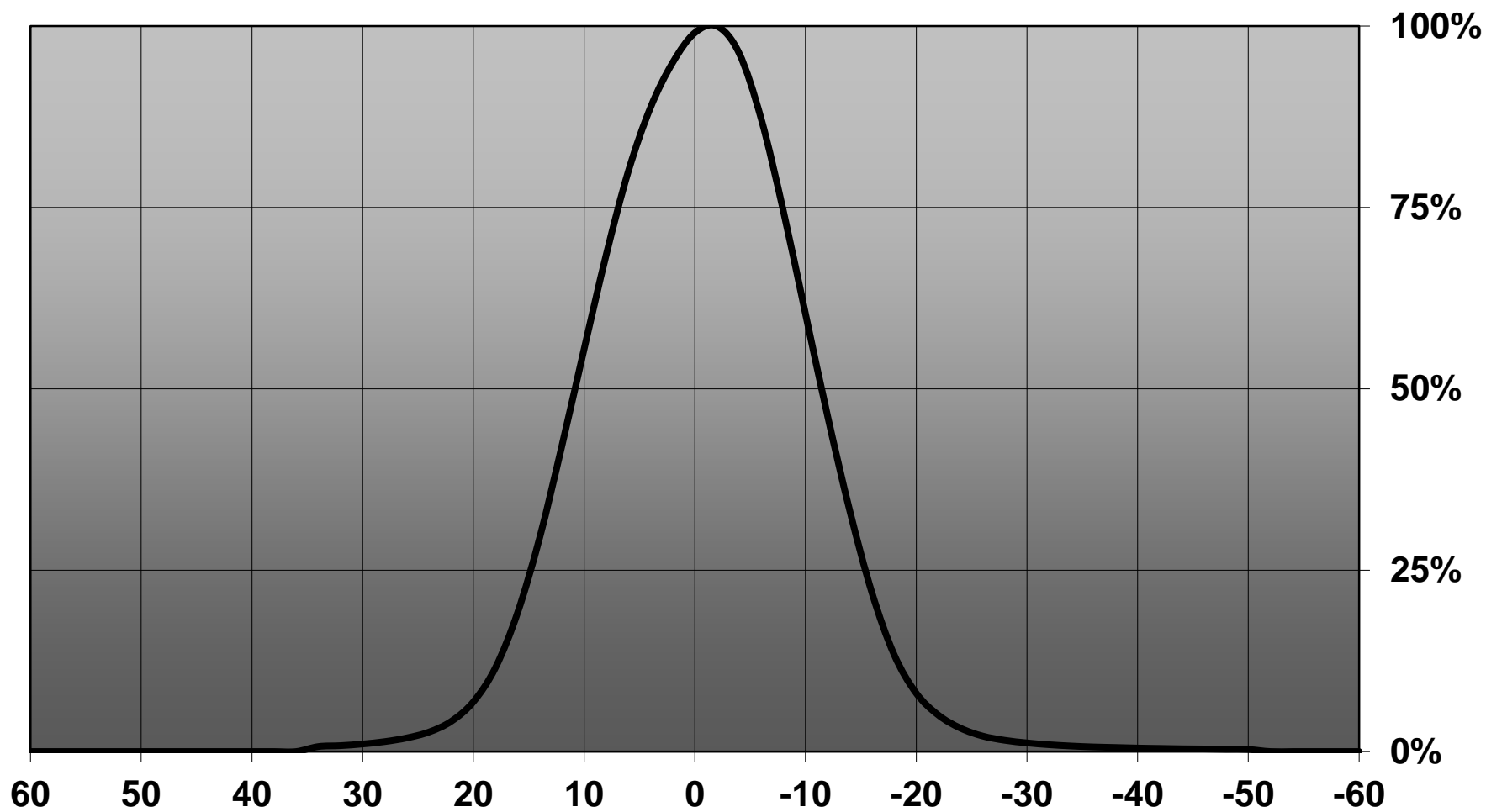

H G F E D C B A

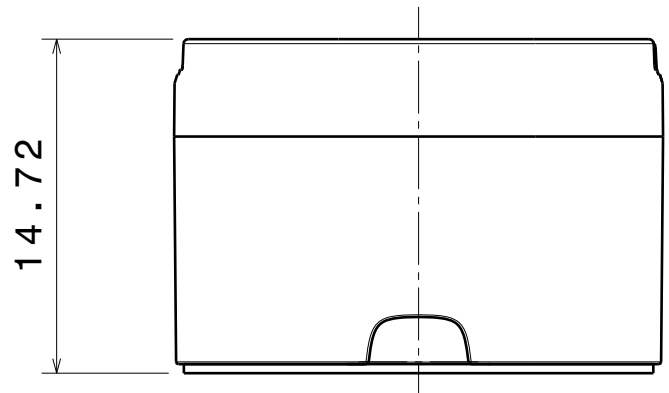

Front view

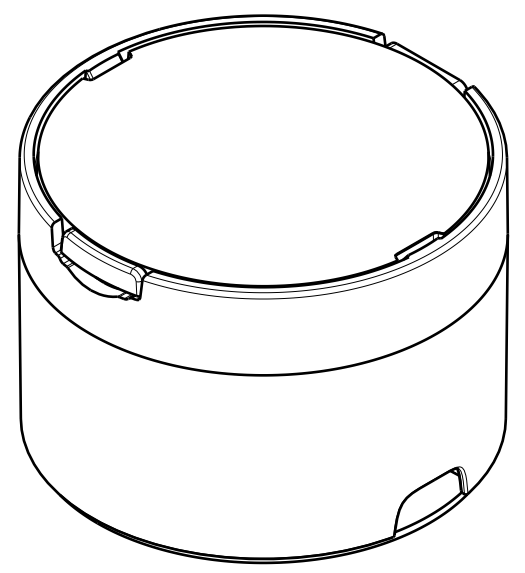

Isometric view

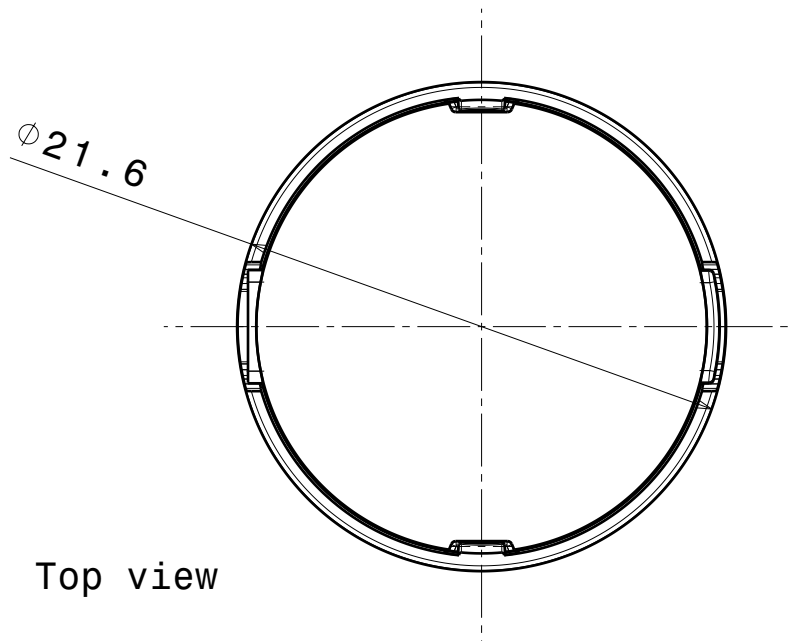

Top view

PU foam tape 0.4mm

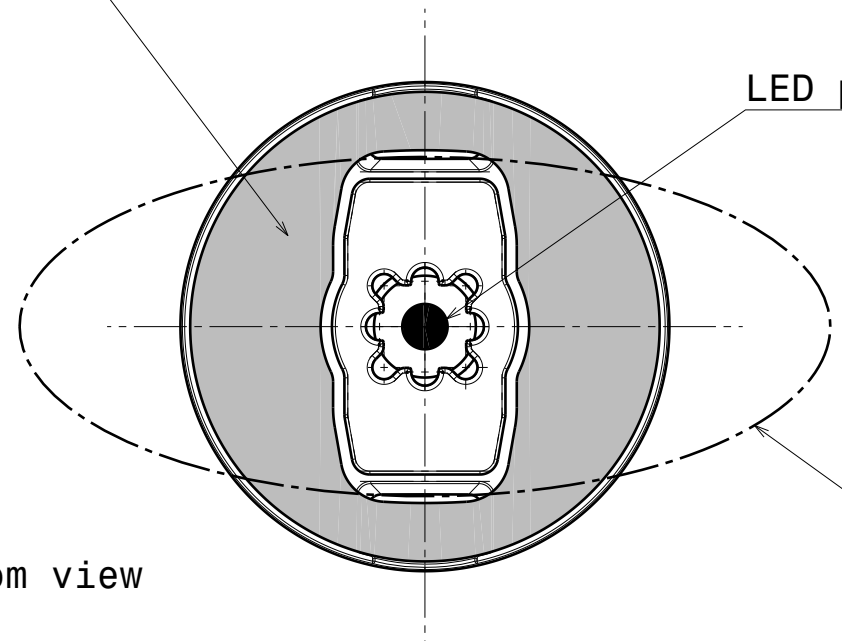

Bottom view

LED position

0-beam direction
0-90 rotated 90 degrees

INDEX	DESCRIPTION	MATERIAL	COLOUR
1	Lens	PMMA	
2	Holder	PC	black

Tolerances if not otherwise shown
According to DIN ISO 2768-1
Linear measures:
up to 30mm class M, otherwise class C
According to DIN ISO 2768-2
Form and position: class L

LEDiL LediL Oy
Salorankatu 10
FIN 24240 SALO
Finland

THIRD ANGLE PROJECTION:

DRAWING TITLE
Datasheet_LXP-Series

This drawing is the property of LEDiL Oy. It may not be reproduced, copied or communicated without a written agreement with LEDiL Oy.

SIZE **A3** PART NUMBER -

SCALE 1:1 WEIGHT - SHEET 1/1

H G B A

Luminaire: Ledil Oy FA11116_LXP-O-90_(XP-E)_SIMULATED
Lamps: 1 x Cree XP-E

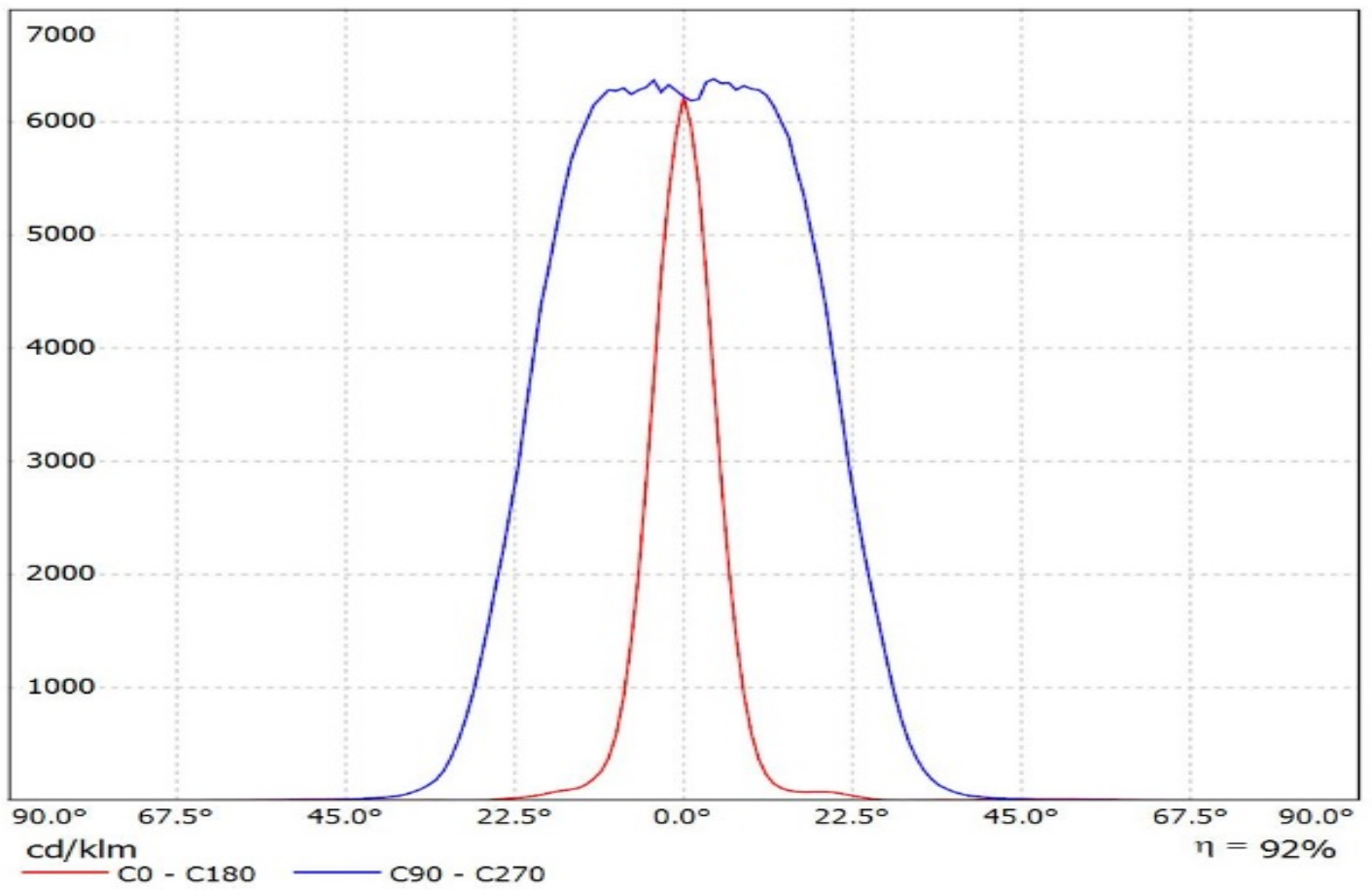

Ledil Oy CA11481_LXP2-RS CA11481_LXP2-RS / LDC (Linear)

Luminaire: Ledil Oy CA11481_LXP2-RS CA11481_LXP2-RS
Lamps: 1 x Cree XP-E (White)

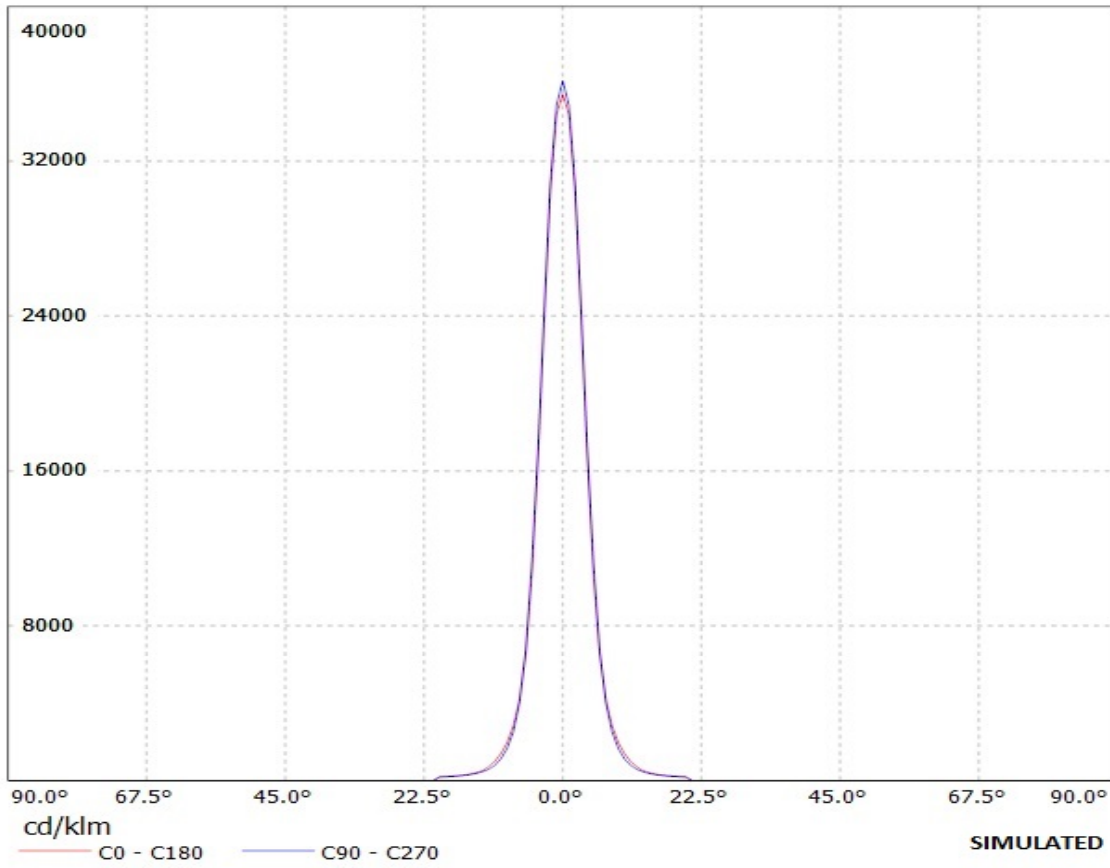

Luminaire: Ledil Oy CP11631_LXP3-RS-XP-E CP11631_LXP3-RS-XP-E
Lamps: 1 x Cree XP-E (White)

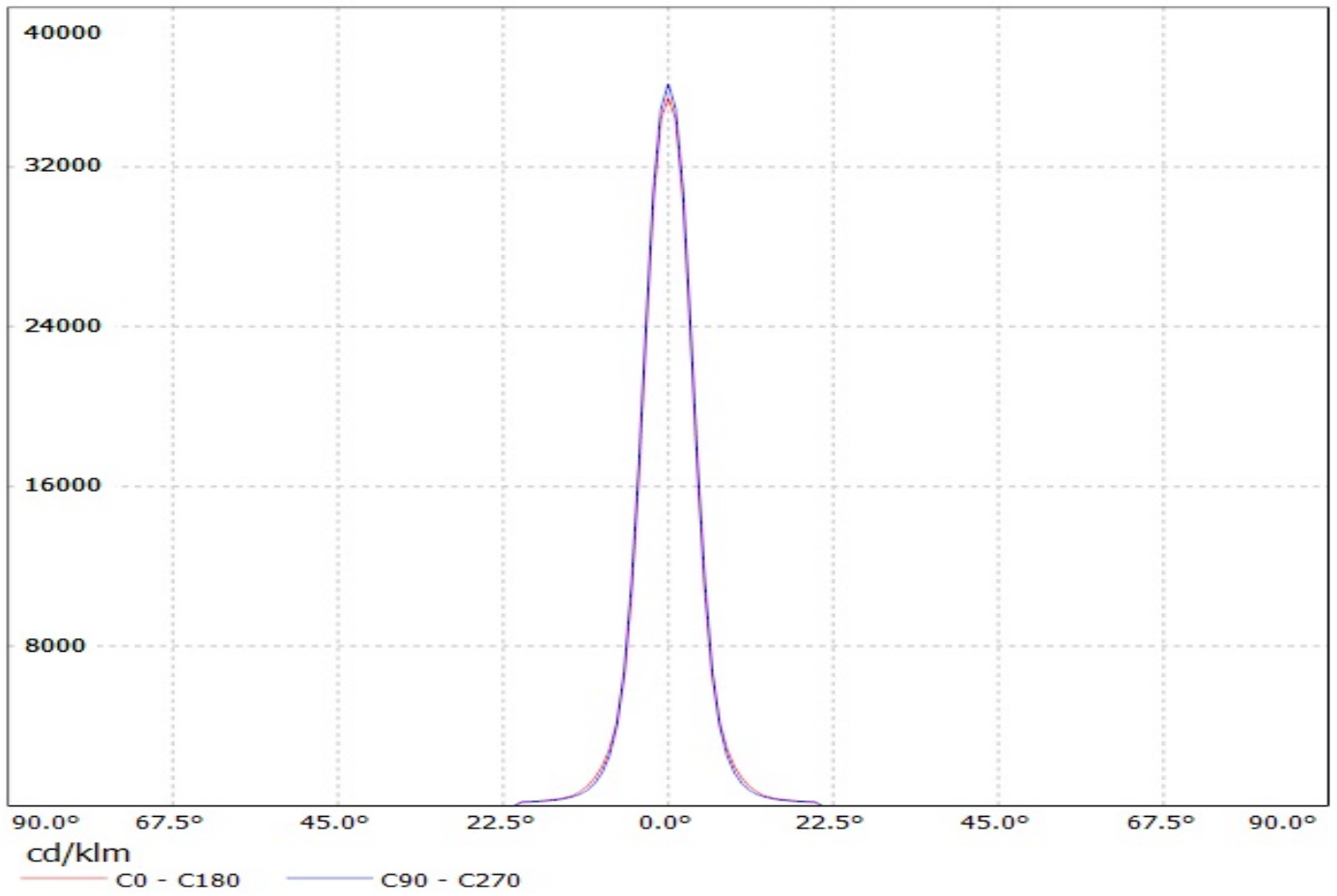

Luminaire: LEDiL Oy FA10661 _(XP-E) Eff.96.5%
Lamps: 1 x XP-E (50.7382lm@250mA)

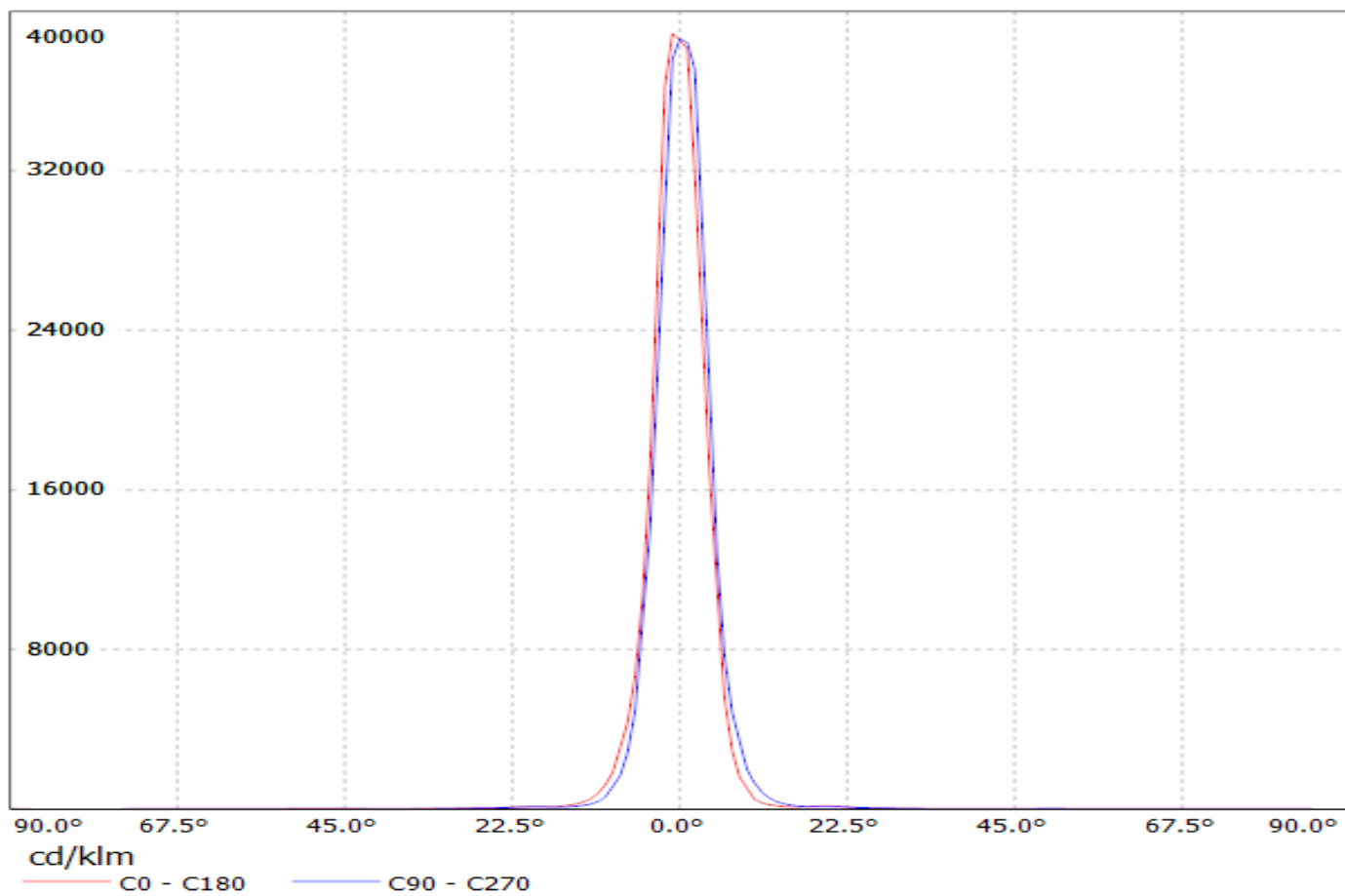

Luminaire: LEDiL Oy CA11484_LXP2-O-90_(XP-E) Eff. 89%
Lamps: 1 x Cree XP-E (50,4lm@250mA) CCT=warm white P=0.8W I=250mA

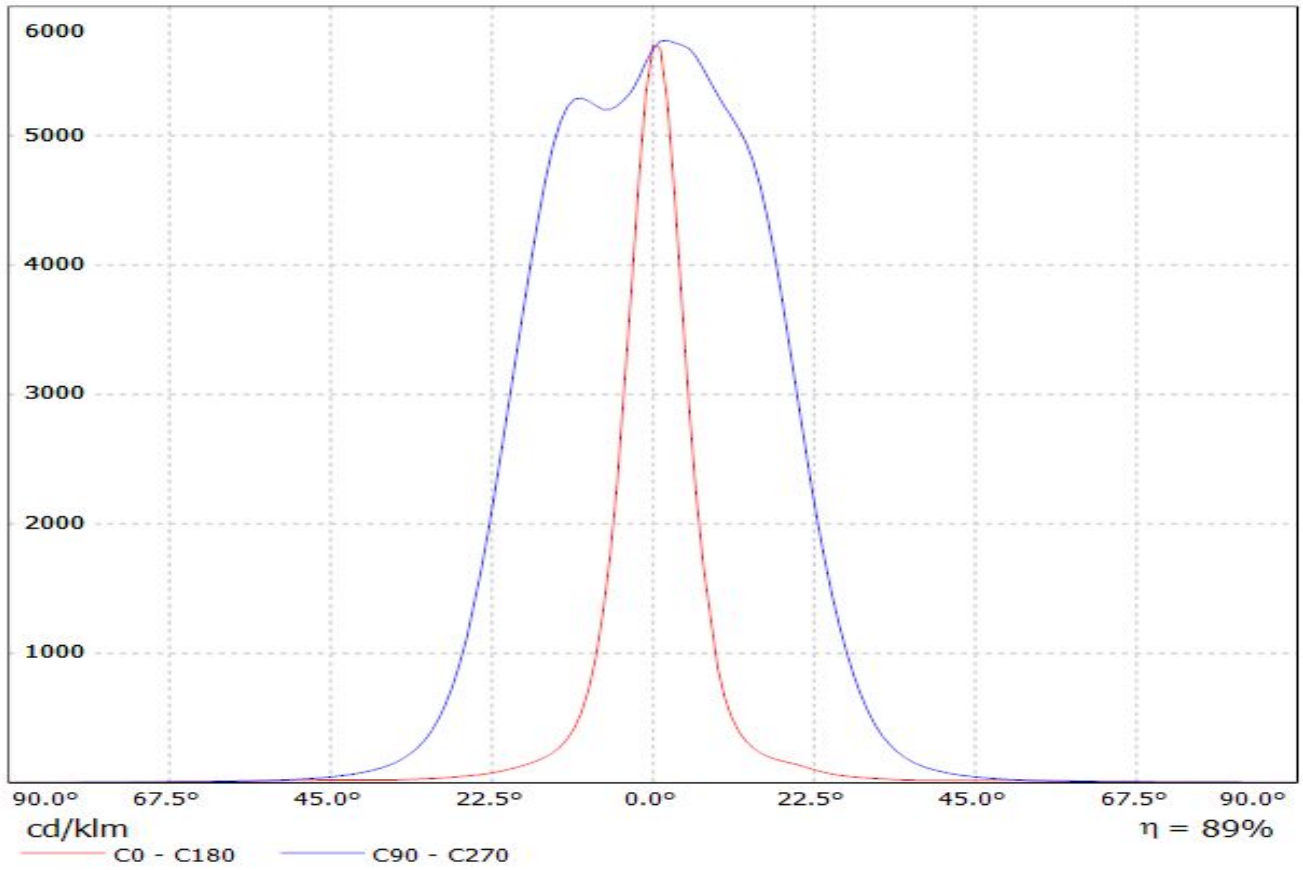

Luminaire: LEDiL Oy CP11634_LXP3-O-90_(XP-E) Eff. 93%
Lamps: 1 x Cree XP-E (50,4lm@250mA) CCT=warm white P=0.8W I=250mA

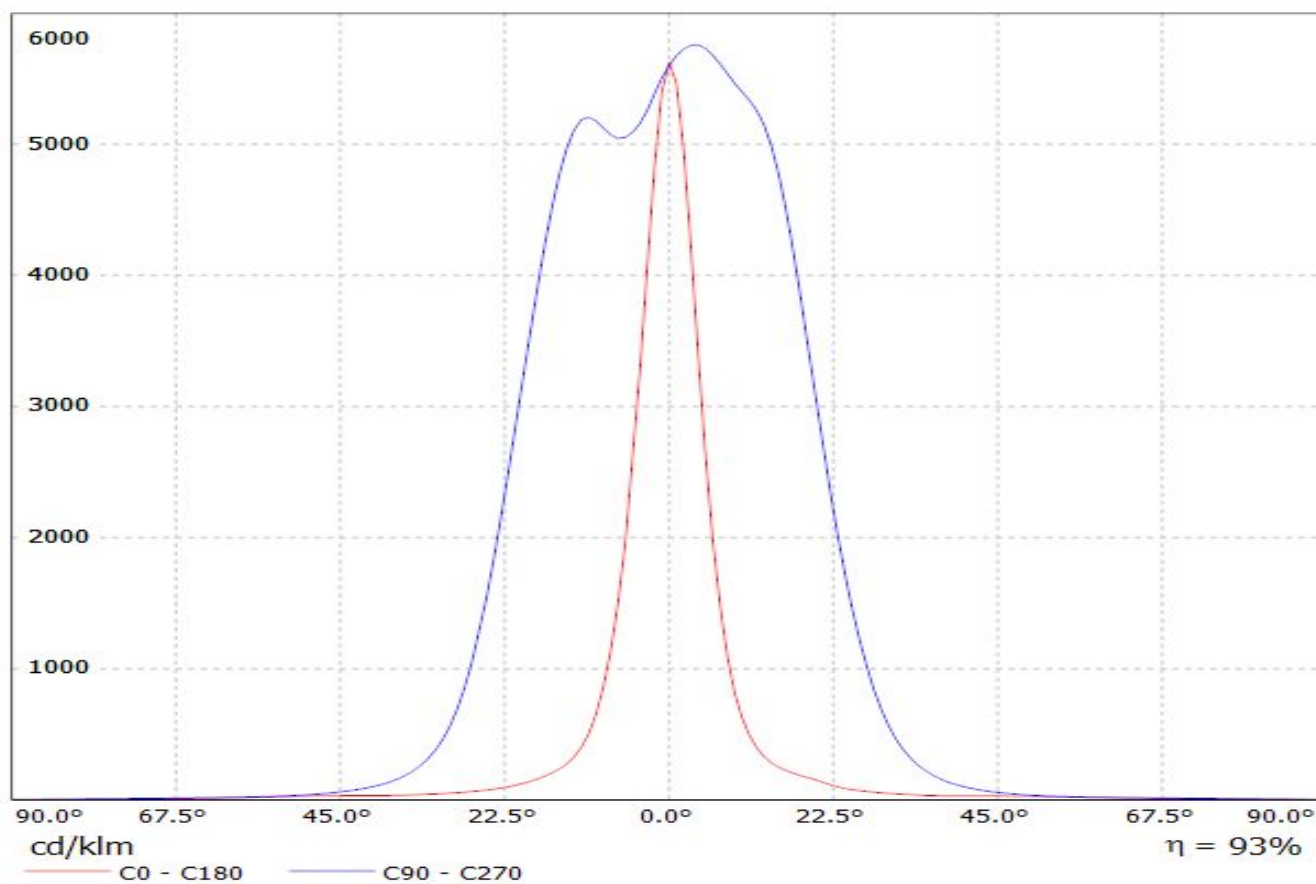

Ledil Oy FA11739_LXP-RS2 LOR=94% / LDC (Linear)

Luminaire: Ledil Oy FA11739_LXP-RS2 LOR=94%
Lamps: 1 x Cree XP-E 72lm 250mA

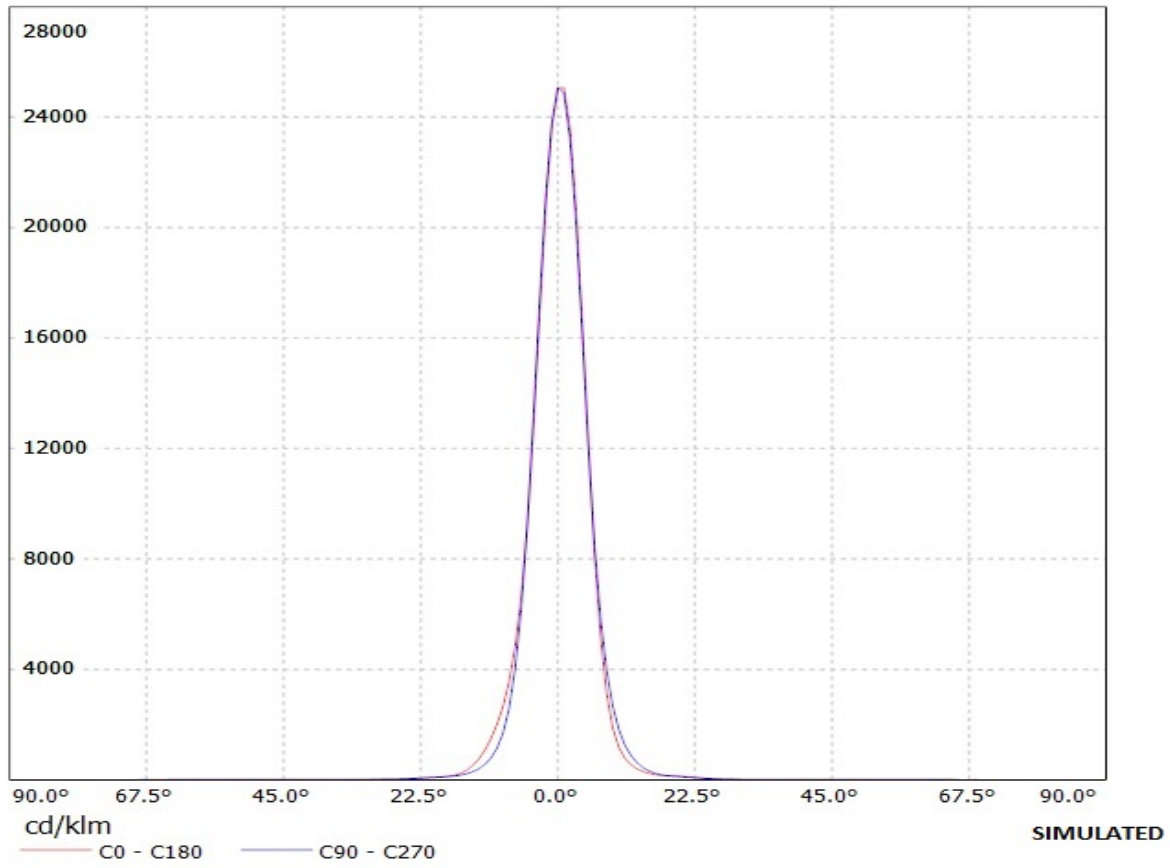

Ledil Oy FA10663_LXP-D FA10663_LXP-D / LDC (Linear)

Luminaire: Ledil Oy FA10663_LXP-D FA10663_LXP-D
Lamps: 1 x Cree XP-E (white)

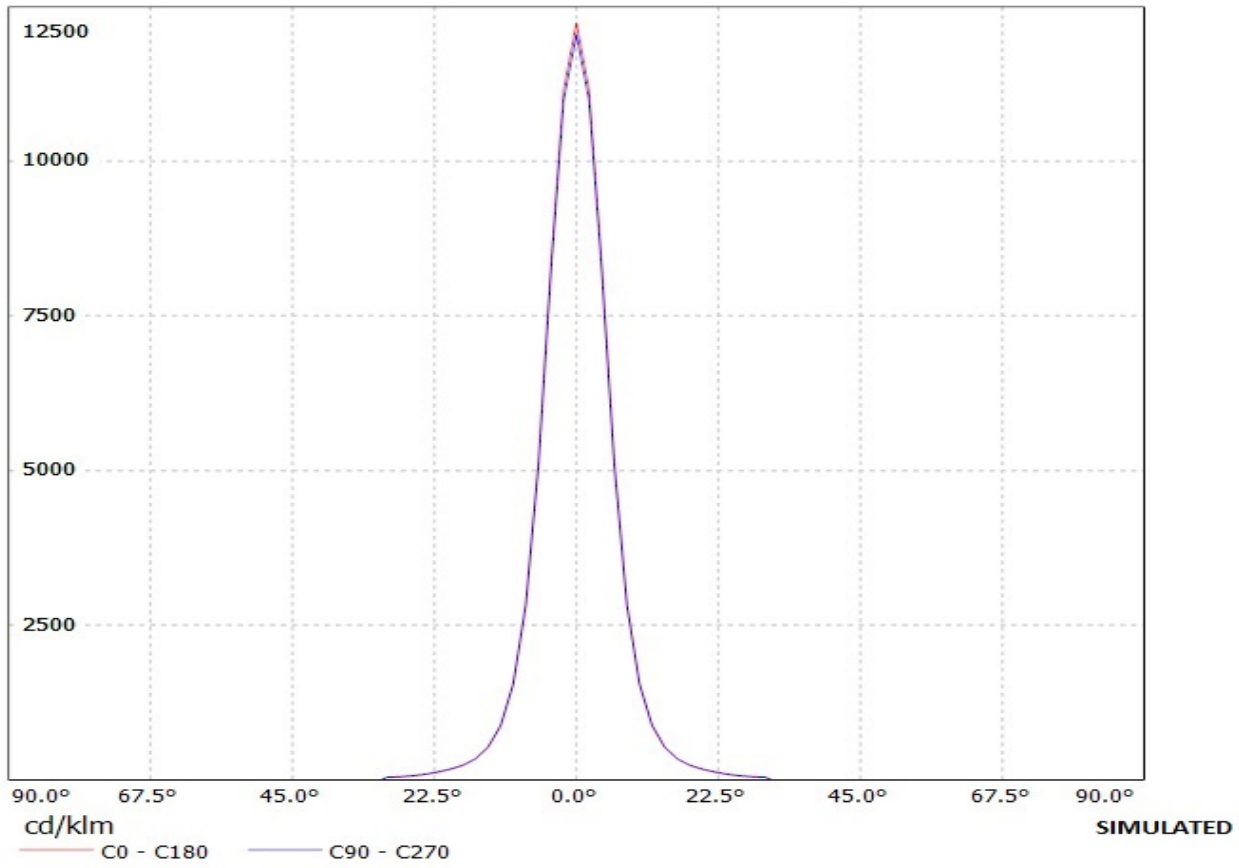

Luminaire: Ledil Oy CP11632_LXP3-D-XP-E CP11632_LXP3-D-XP-E
Lamps: 1 x Cree XP-E (White)

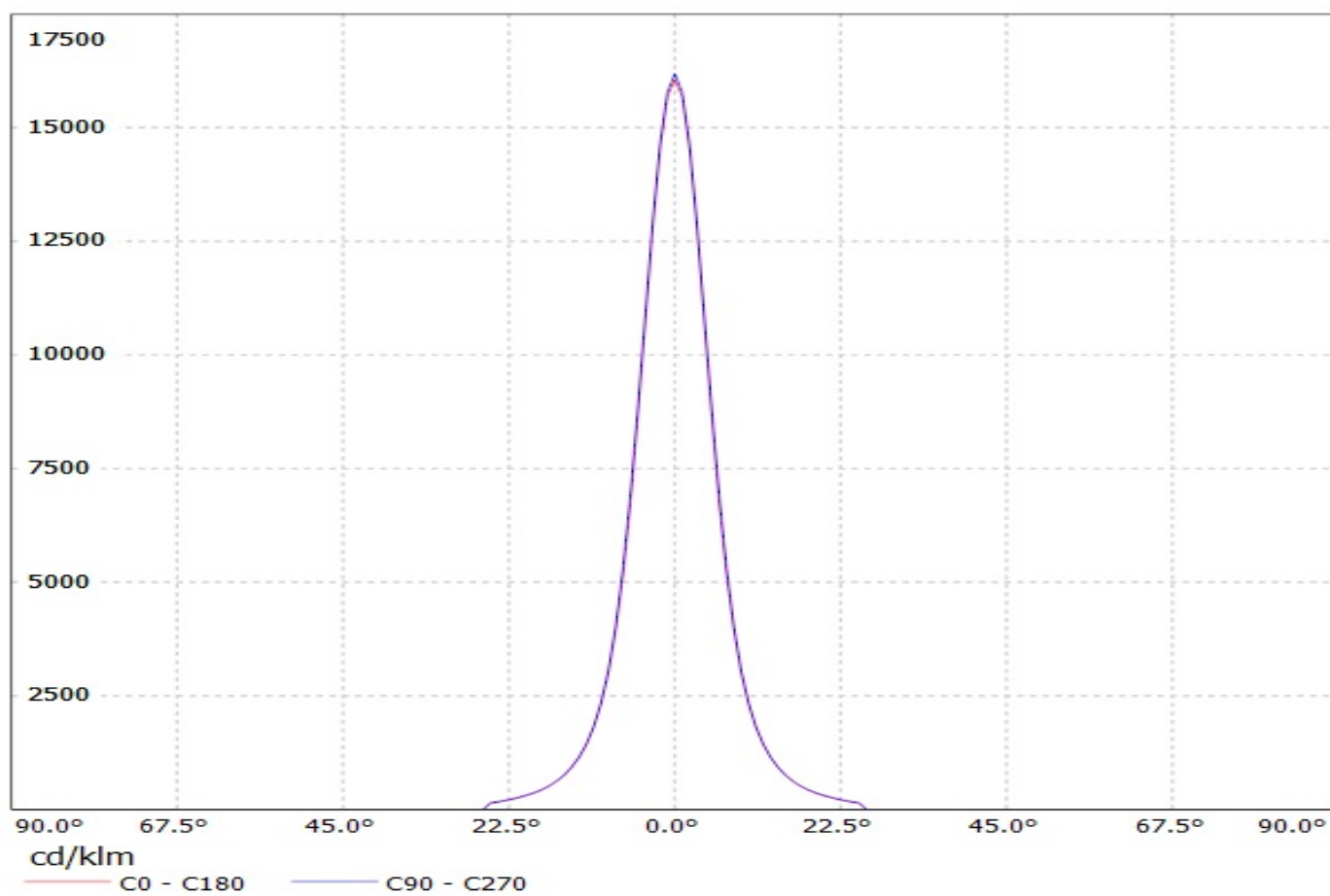

Ledil Oy FA10660_LXP-M FA10660_LXP-M / LDC (Linear)

Luminaire: Ledil Oy FA10660_LXP-M FA10660_LXP-M
Lamps: 1 x Cree XP-E (White)

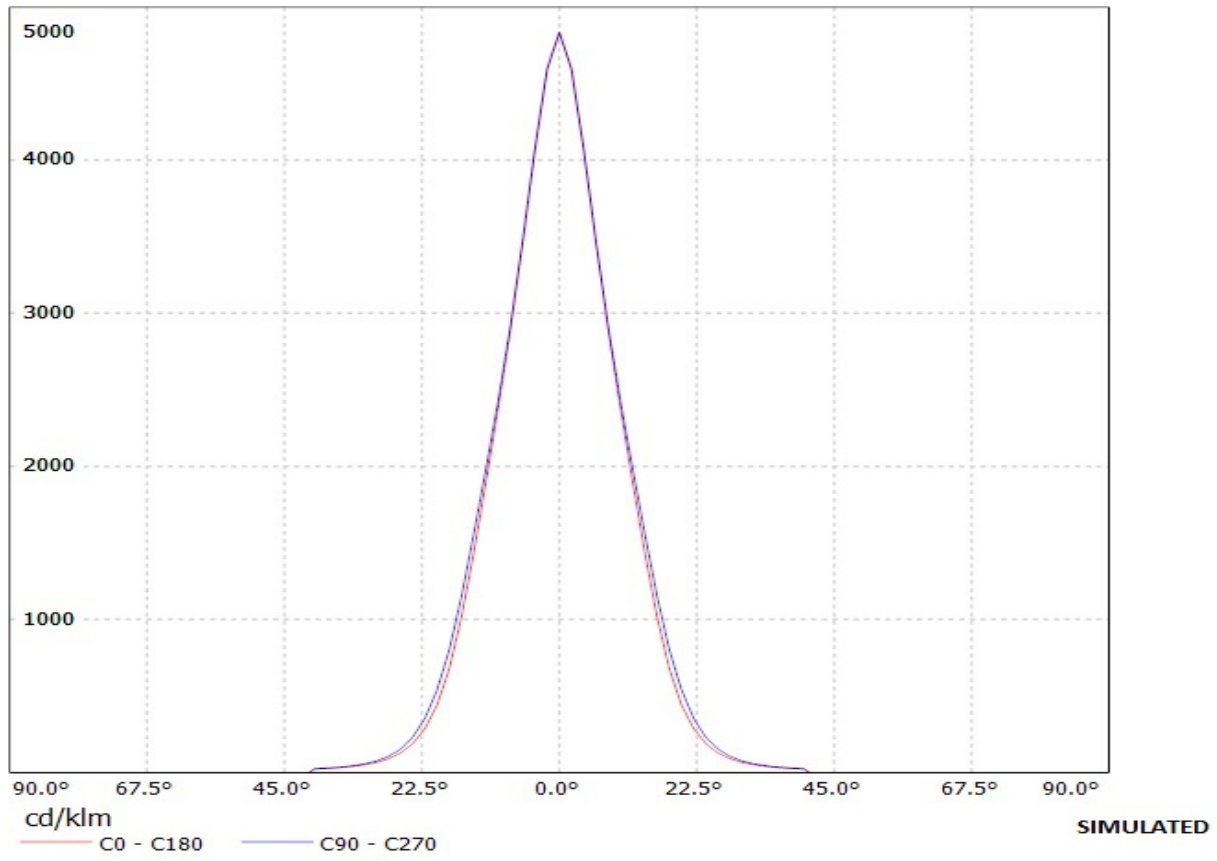

Luminaire: Ledil Oy CP11633_LXP3-M-XP-E LOR=93%
Lamps: 1 x Cree XP-E 250mA 77lm

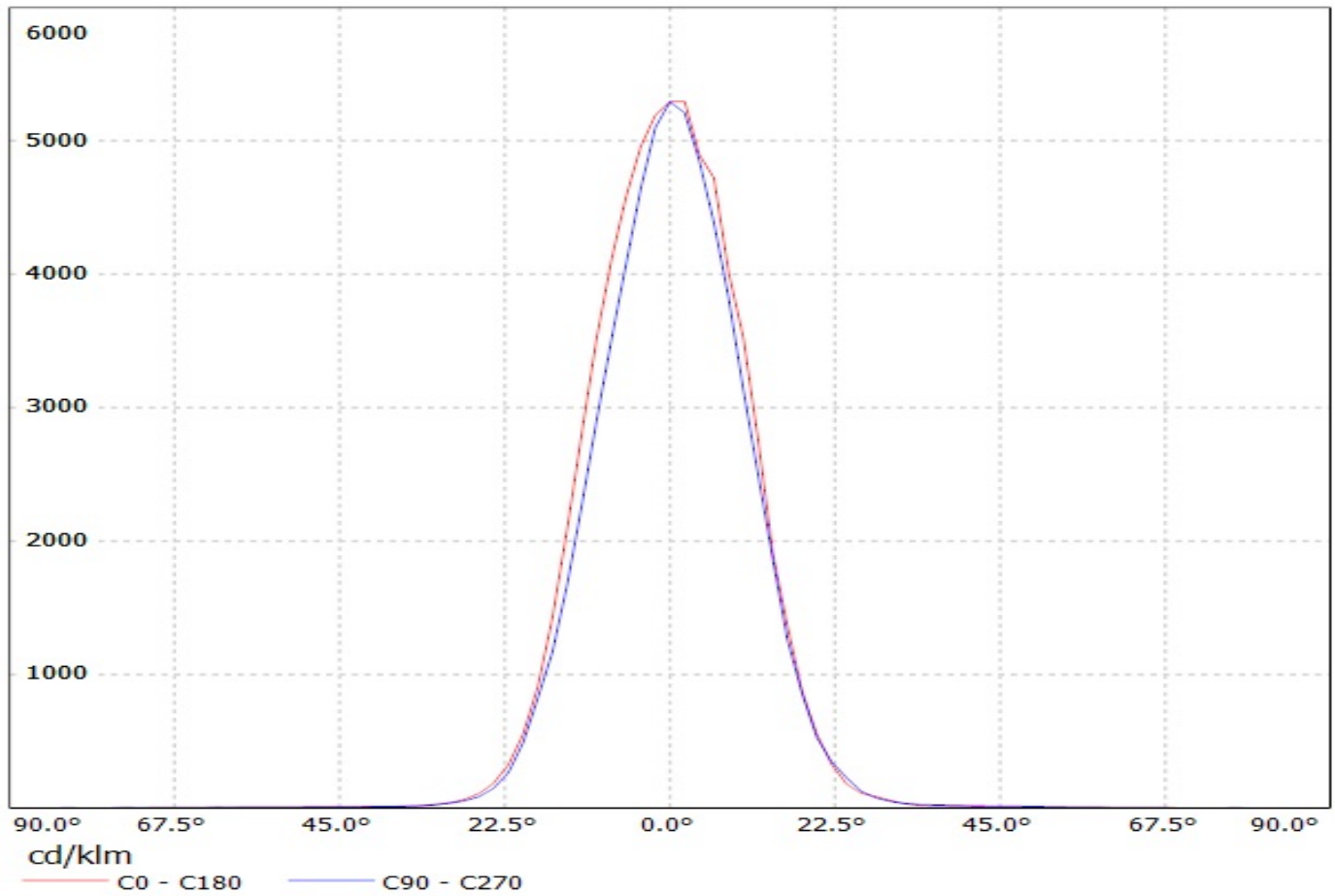

Luminaire: Ledil Oy FA12218_LXP-O (Cree XP-E 76lm @ 250mA) Efficiency=89%
Lamps: 1 x Cree XP-E 76lm @ 250mA

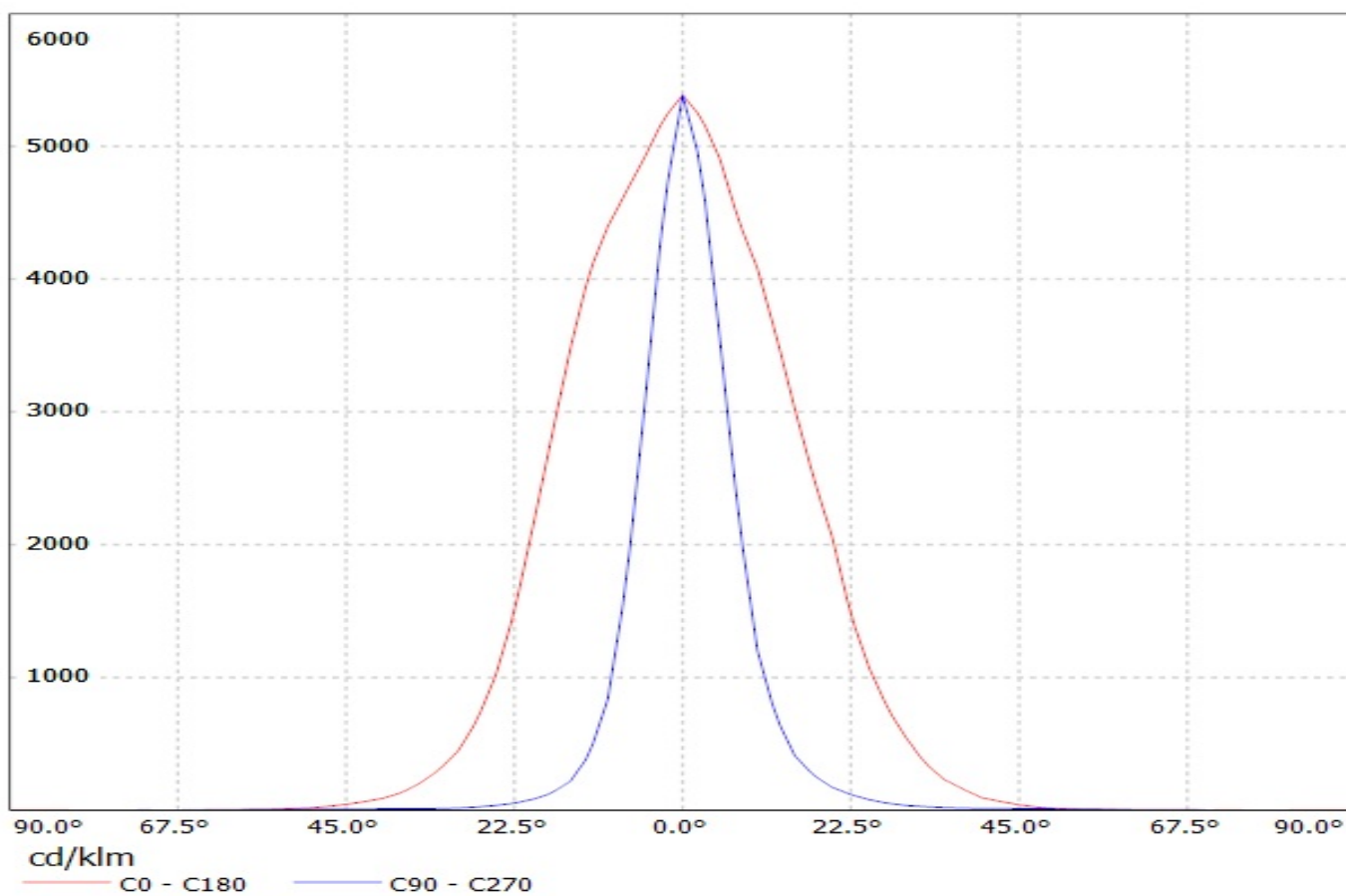

Luminaire: Ledil Oy FA10662_LXP-REC_(XP-E) Efficiency=82%
Lamps: 1 x FA10662_LXP-REC_(XP-E) 50.36lm @ 250mA CCT=2864K P=0.80W I=250mA

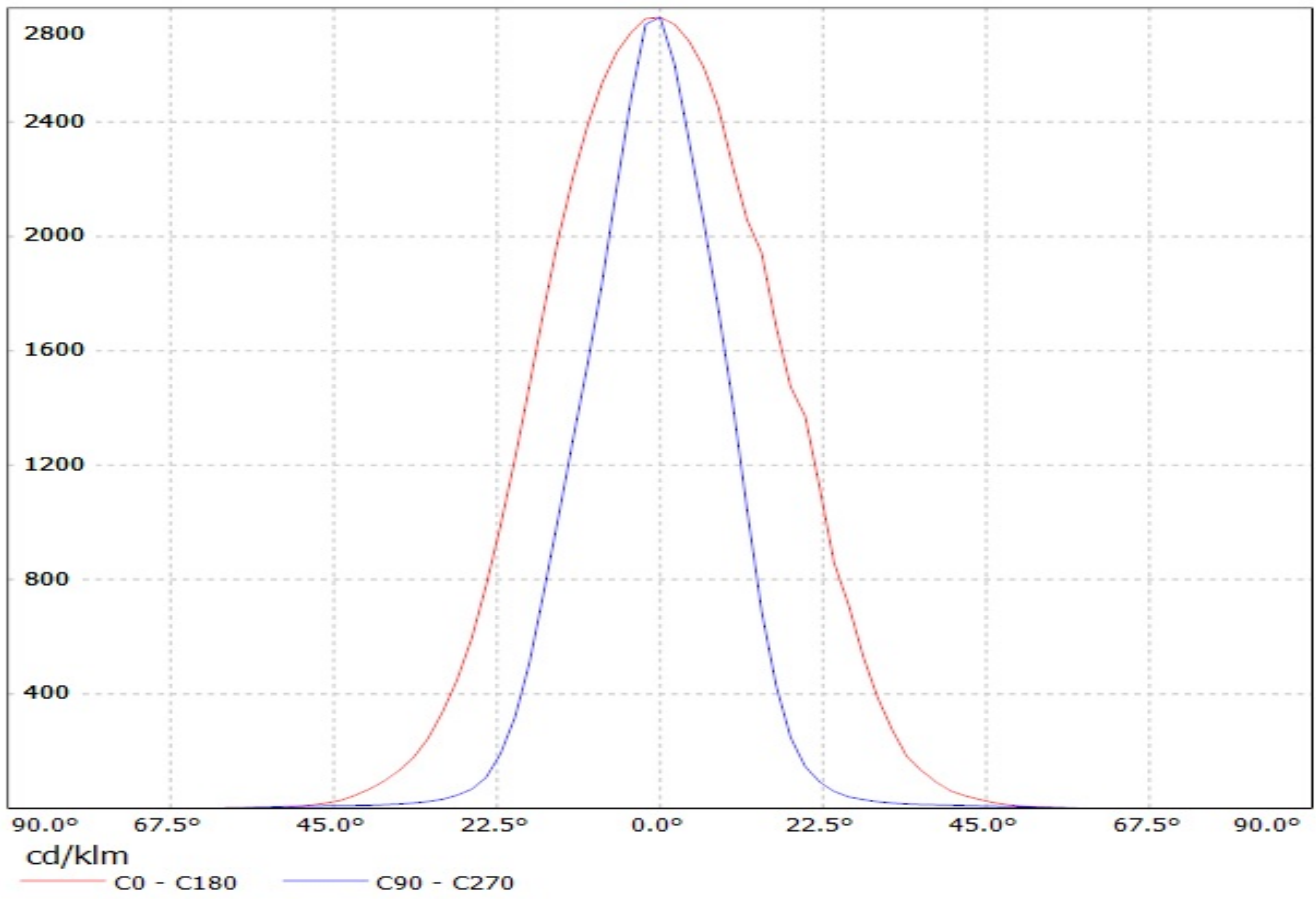

Luminaire: Ledil Oy CP12395_LXP3-W (Cree XP-E 76lm @ 250mA) Efficiency=92%
Lamps: 1 x Cree XP-E 76lm @ 250mA

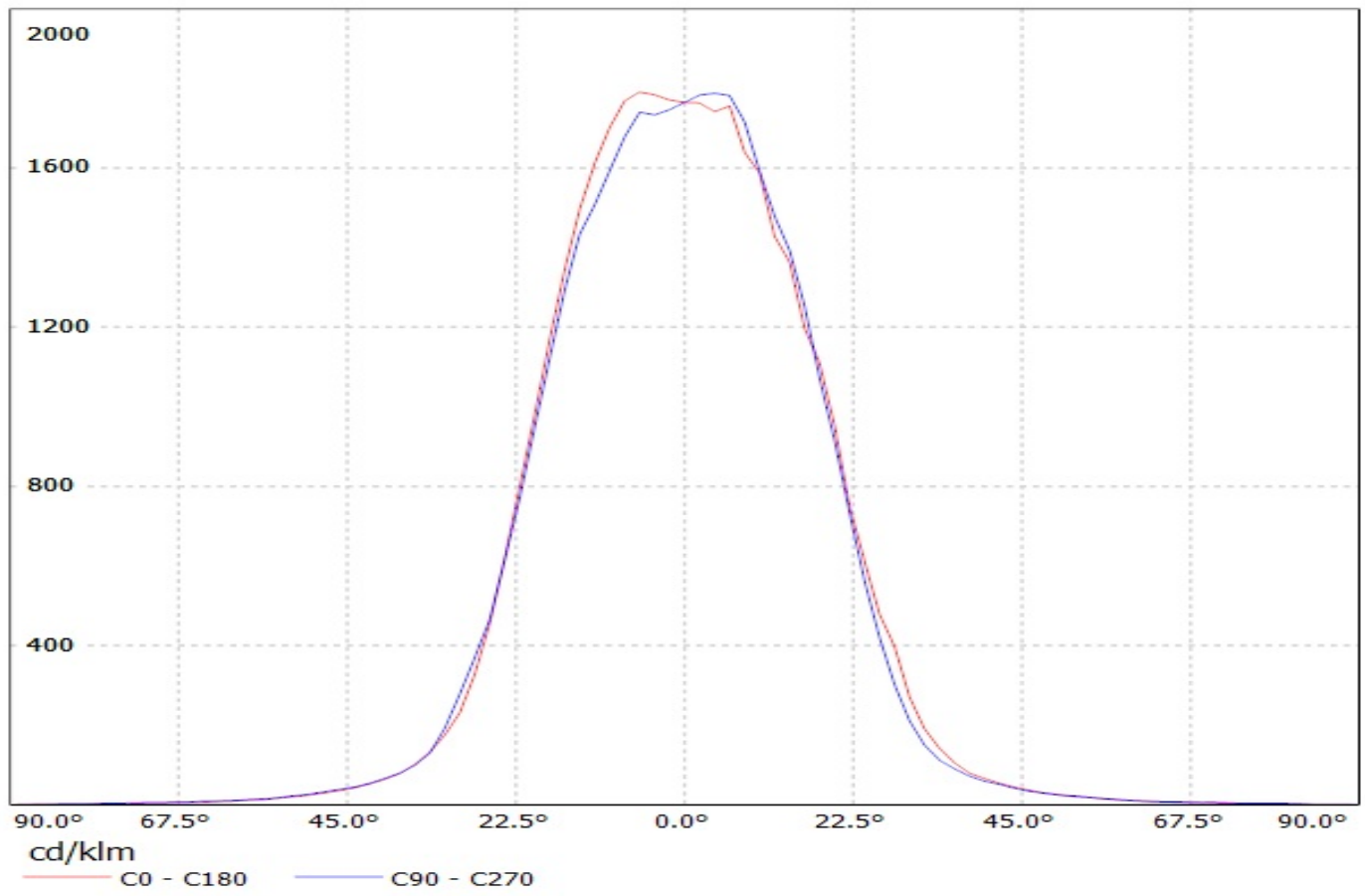

Luminaire: LEDIL OY FA10832_LXP-W_(XP-E)
Lamps: 1 x XP-E (71.84lm)

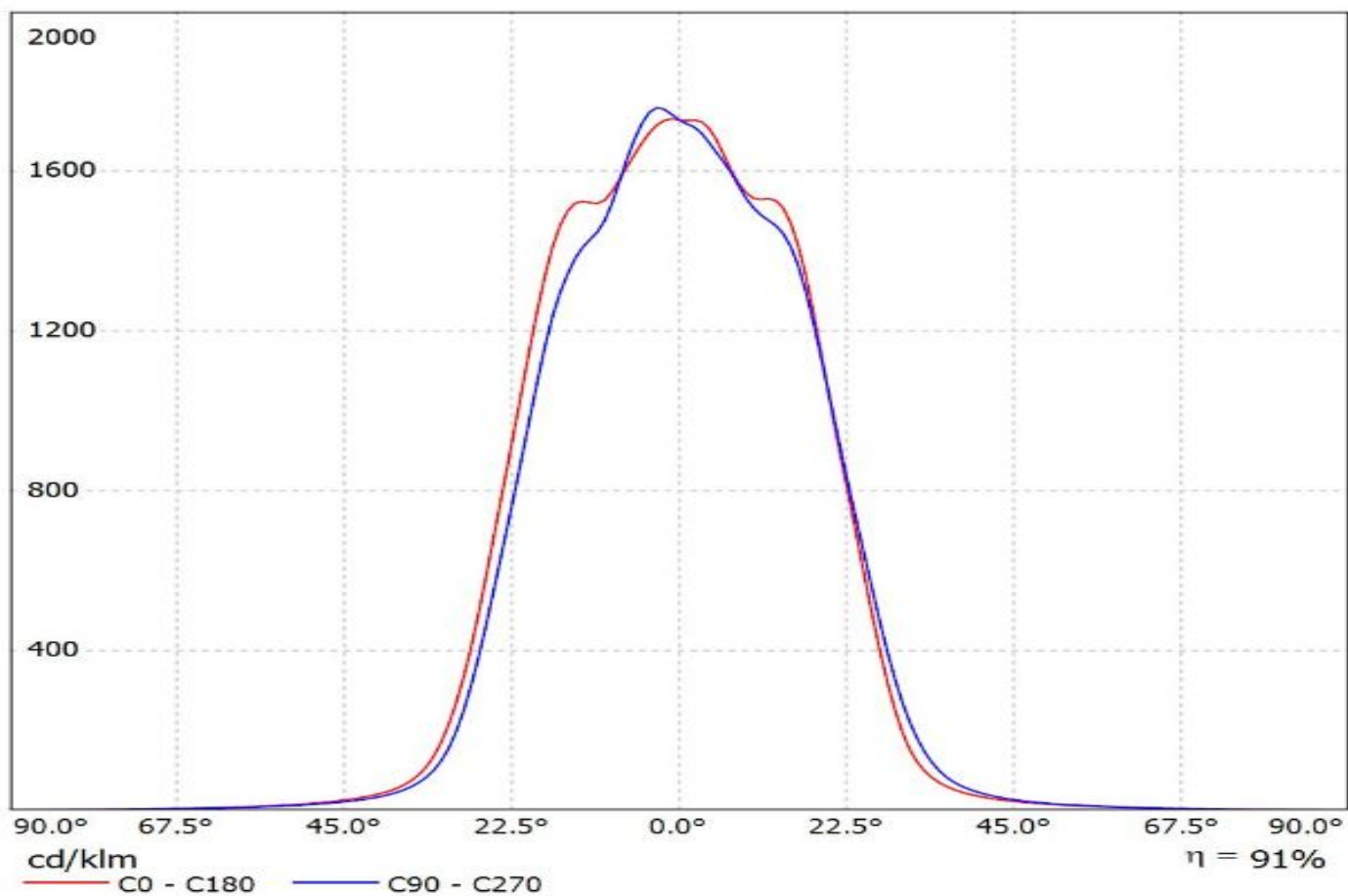

Luminaire: Ledil Oy CA12392_LXP2-W (Cree XP-E 77lm @ 250mA) Efficiency=90%
Lamps: 1 x Cree XP-E 77lm @ 250mA

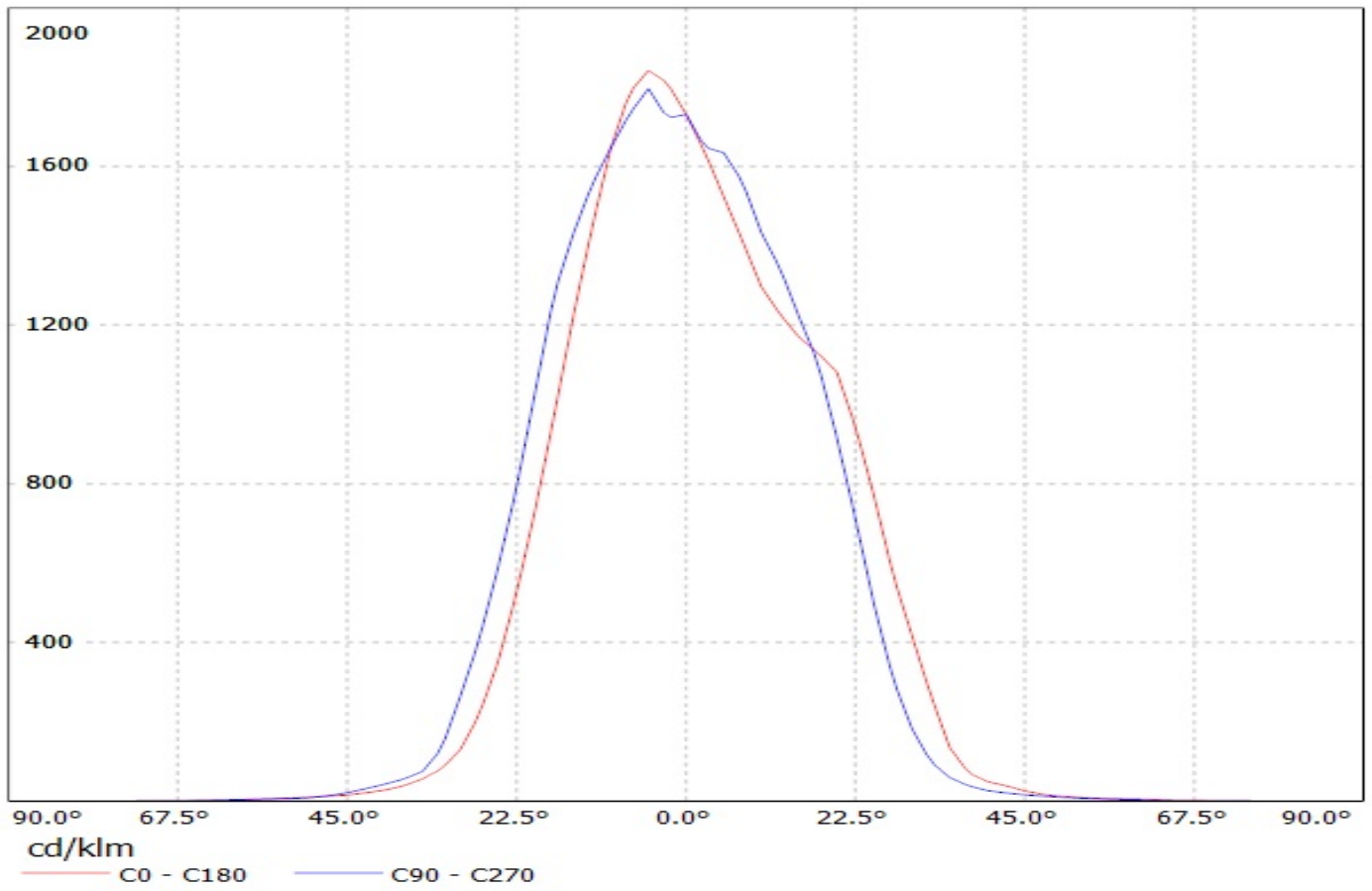

Luminaire: Ledil Oy FA11116_LXP-O-90_(XP-E)_SIMULATED
Lamps: 1 x Cree XP-E

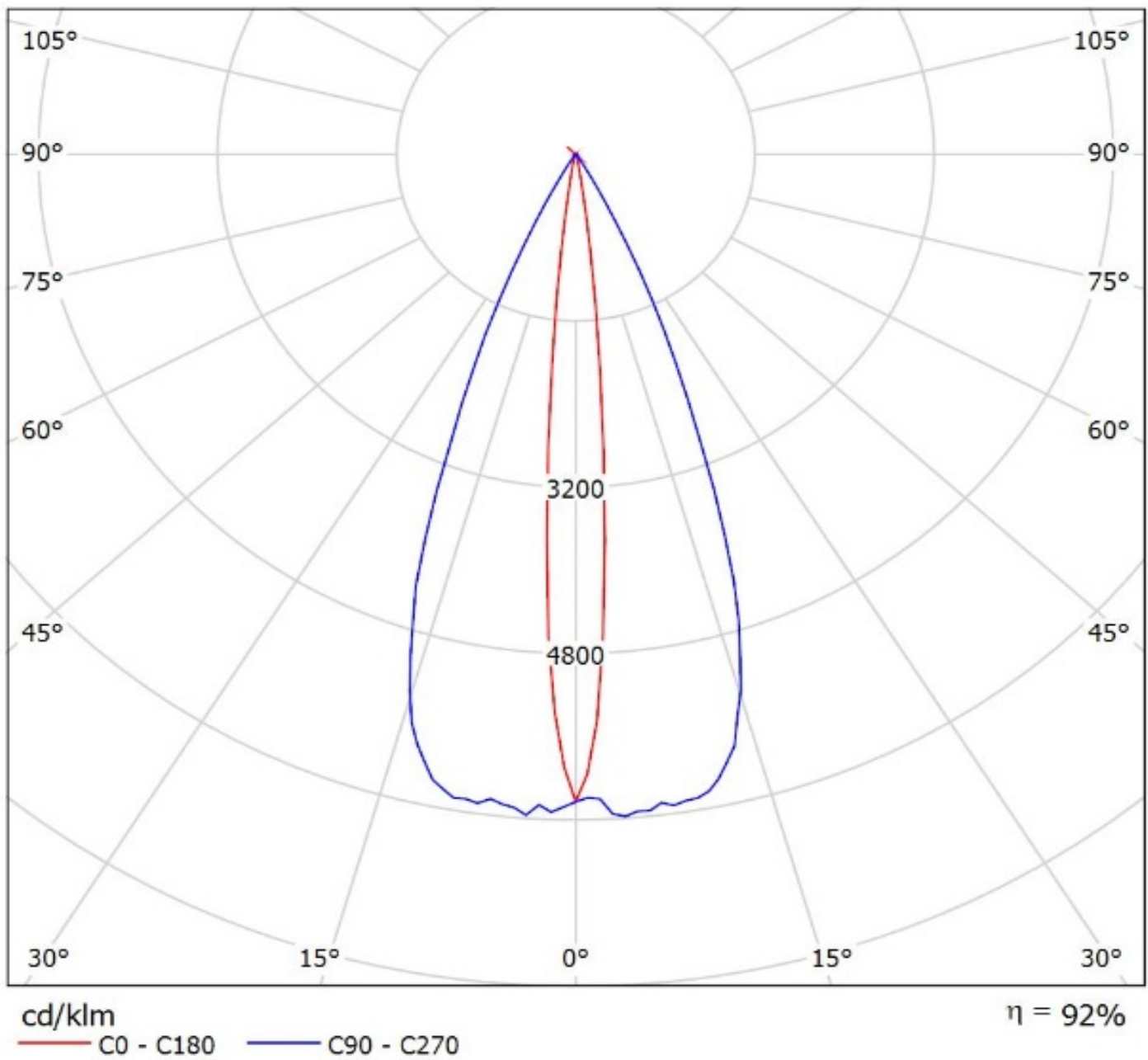

Ledil Oy CA11481_LXP2-RS CA11481_LXP2-RS / LDC (Polar)

Luminaire: Ledil Oy CA11481_LXP2-RS CA11481_LXP2-RS

Lamps: 1 x Cree XP-E (White)

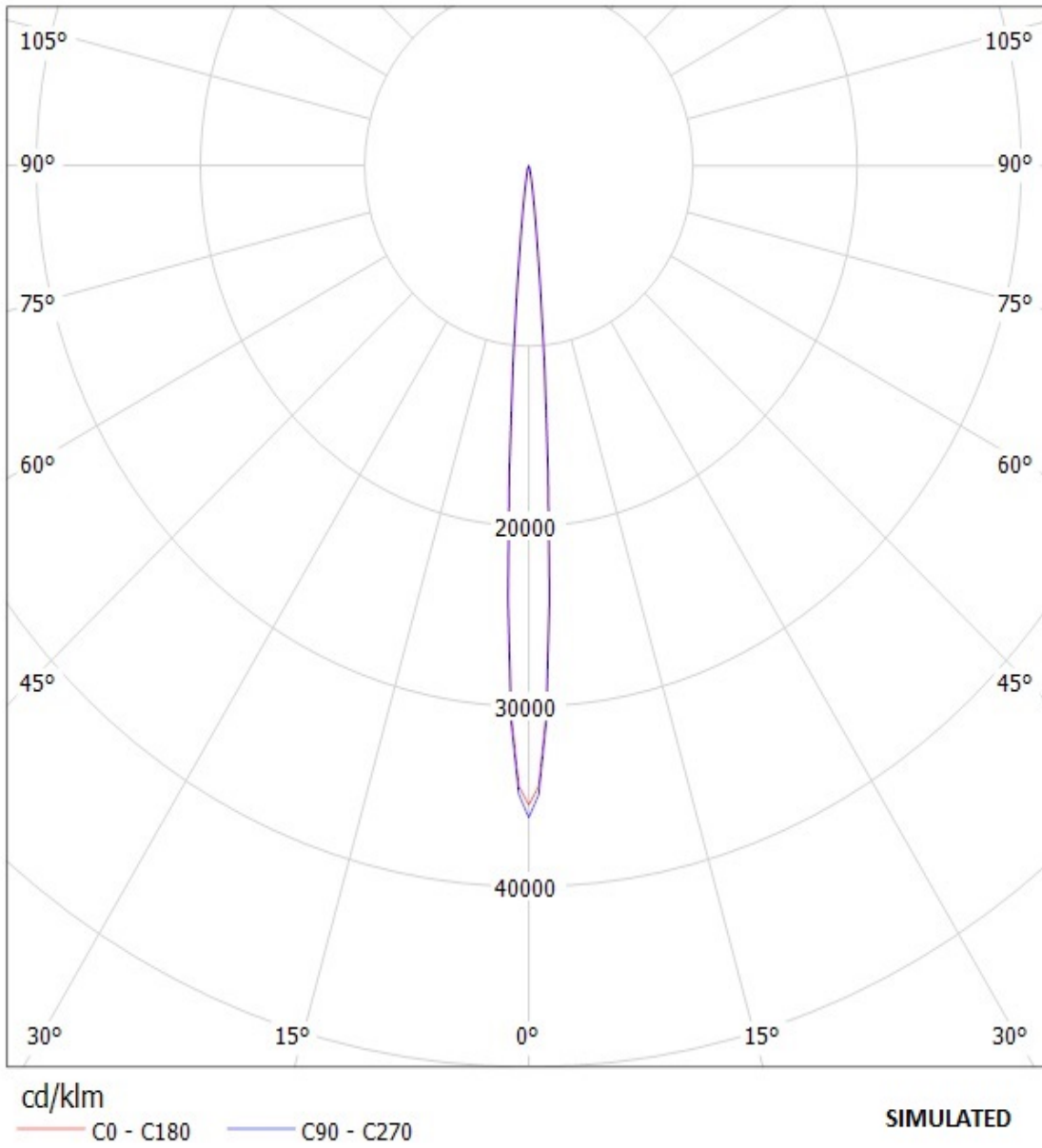

Luminaire: Ledil Oy CP11631_LXP3-RS-XP-E CP11631_LXP3-RS-XP-E
Lamps: 1 x Cree XP-E (White)

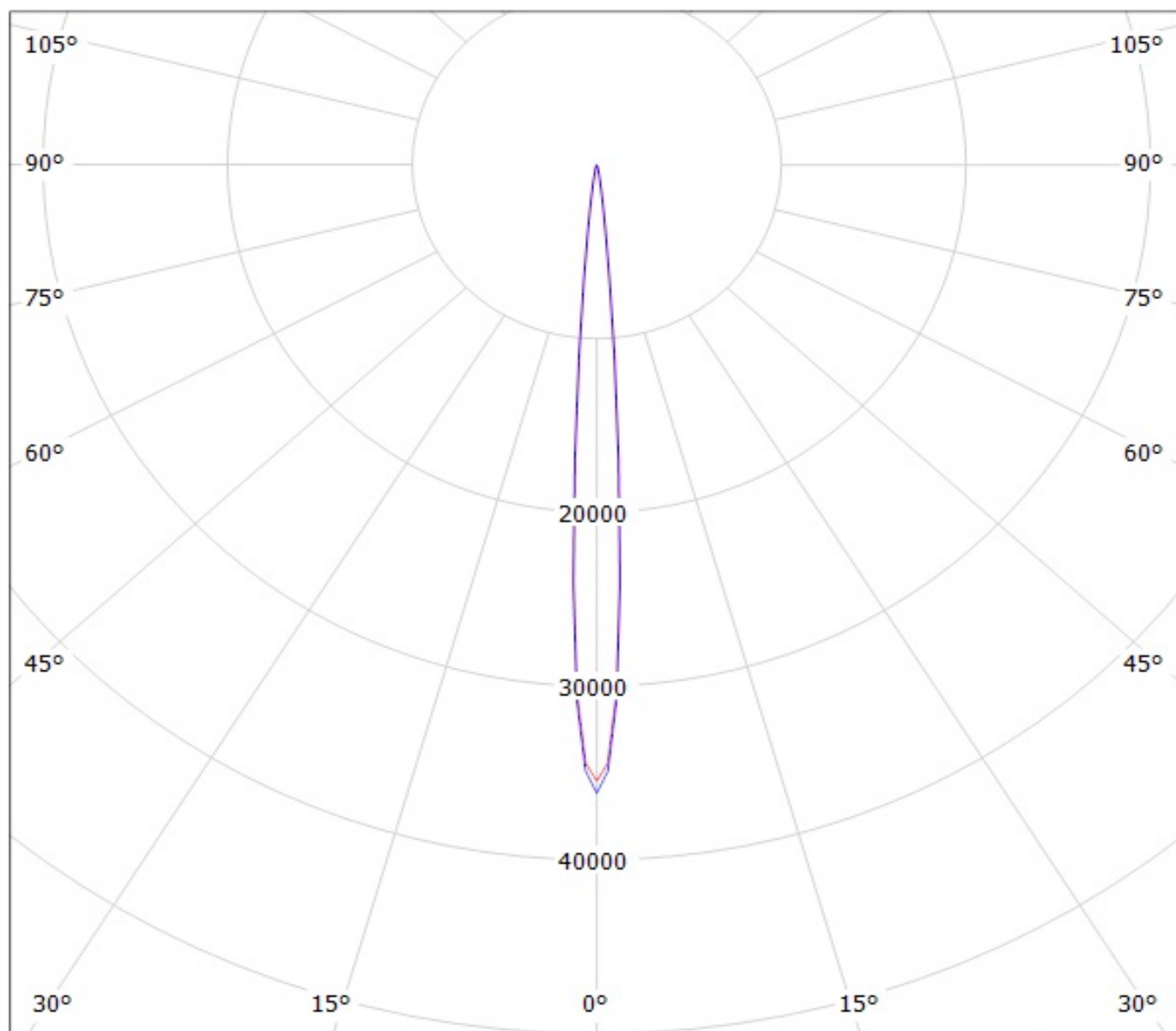

cd/klm

— C0 - C180

— C90 - C270

Luminaire: LEDiL Oy FA10661 _(XP-E) Eff.96.5%
Lamps: 1 x XP-E (50.7382lm@250mA)

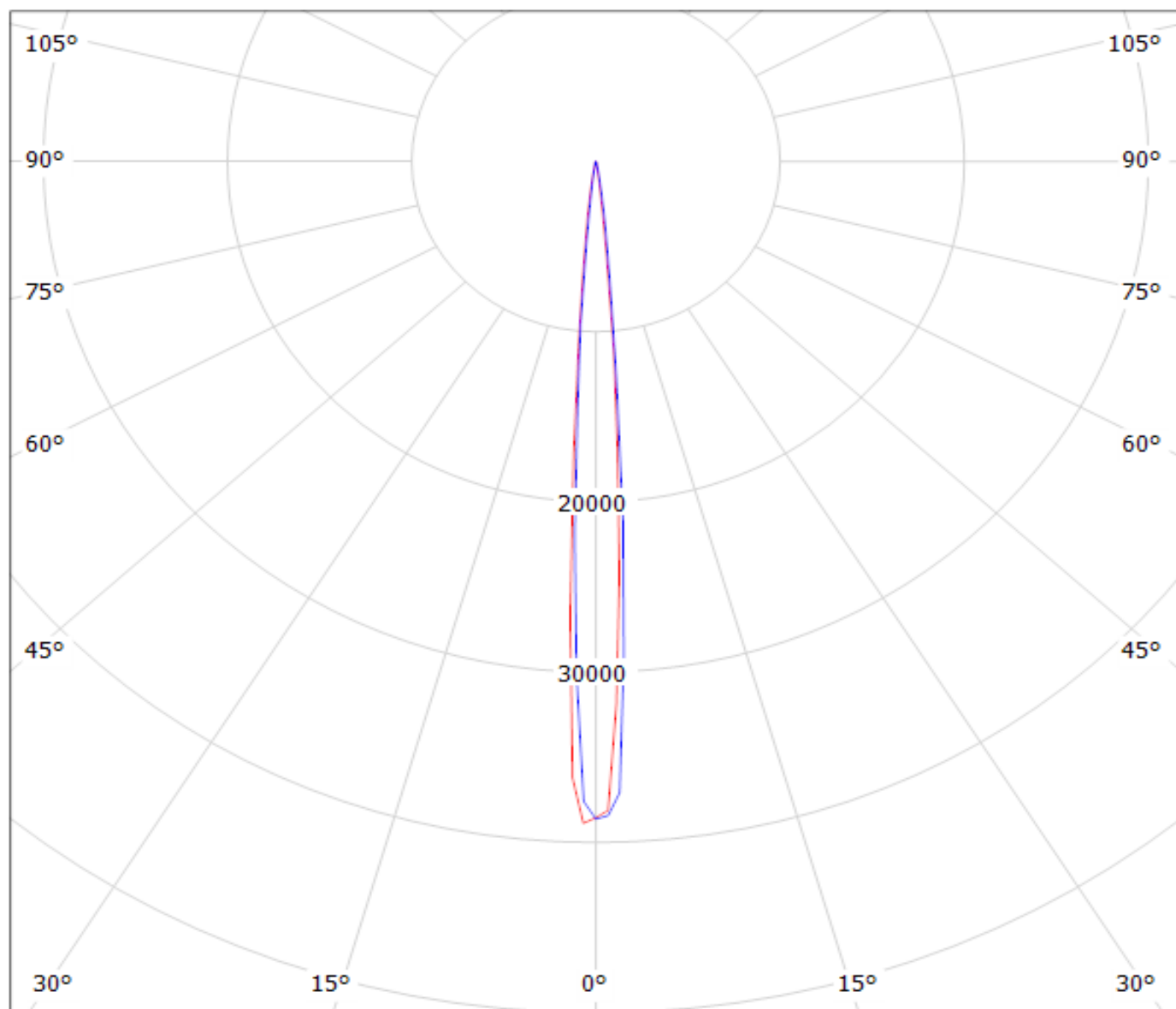

cd/klm

— C0 - C180 — C90 - C270

Luminaire: LEDiL Oy CA11484_LXP2-O-90_(XP-E) Eff. 89%
Lamps: 1 x Cree XP-E (50,4lm@250mA) CCT=warm white P=0.8W I=250mA

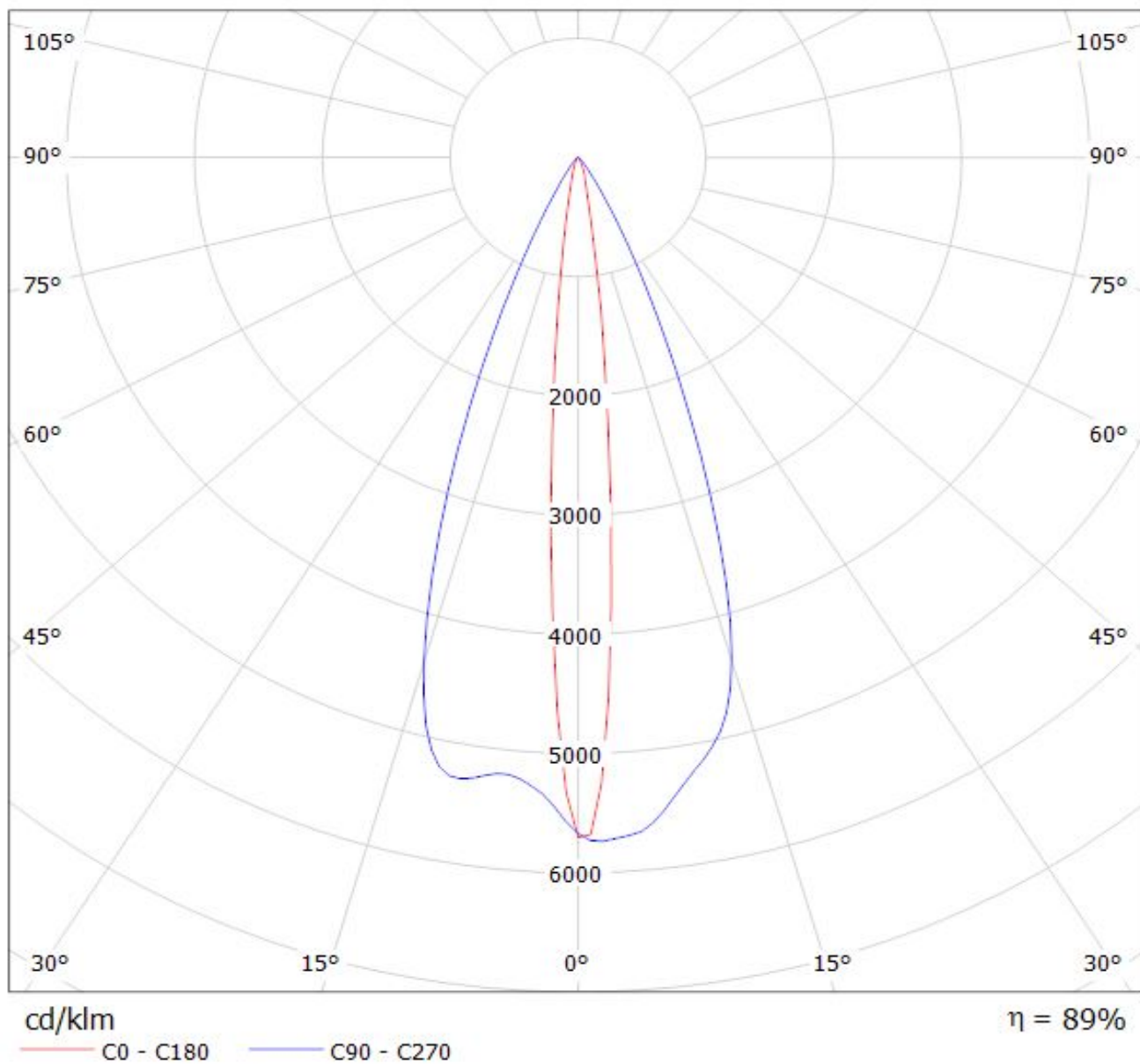

Luminaire: LEDiL Oy CP11634_LXP3-O-90_(XP-E) Eff. 93%
Lamps: 1 x Cree XP-E (50,4lm@250mA) CCT=warm white P=0.8W I=250mA

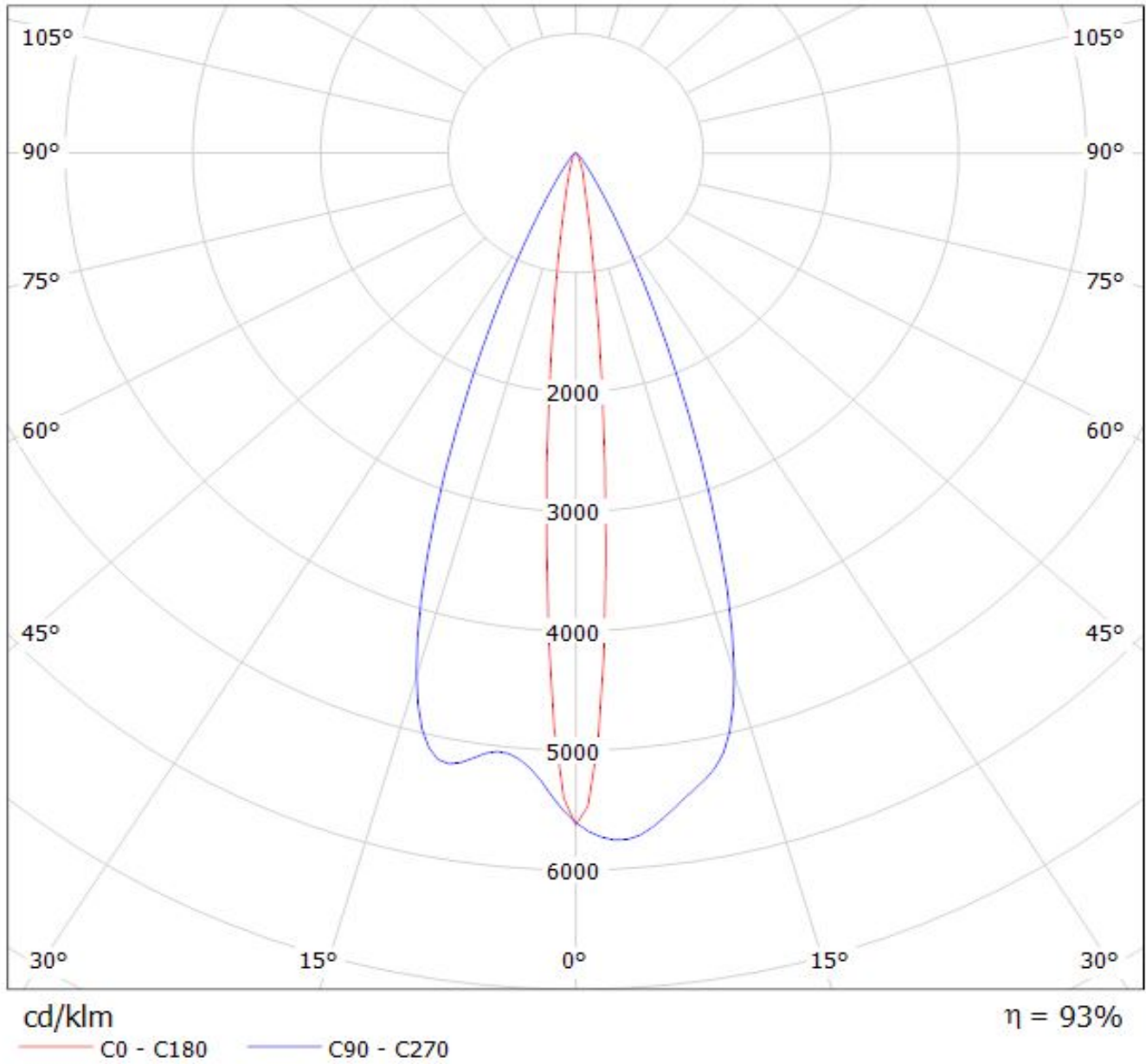

Ledil Oy FA11739_LXP-RS2 LOR=94% / LDC (Polar)

Luminaire: Ledil Oy FA11739_LXP-RS2 LOR=94%
Lamps: 1 x Cree XP-E 72lm 250mA

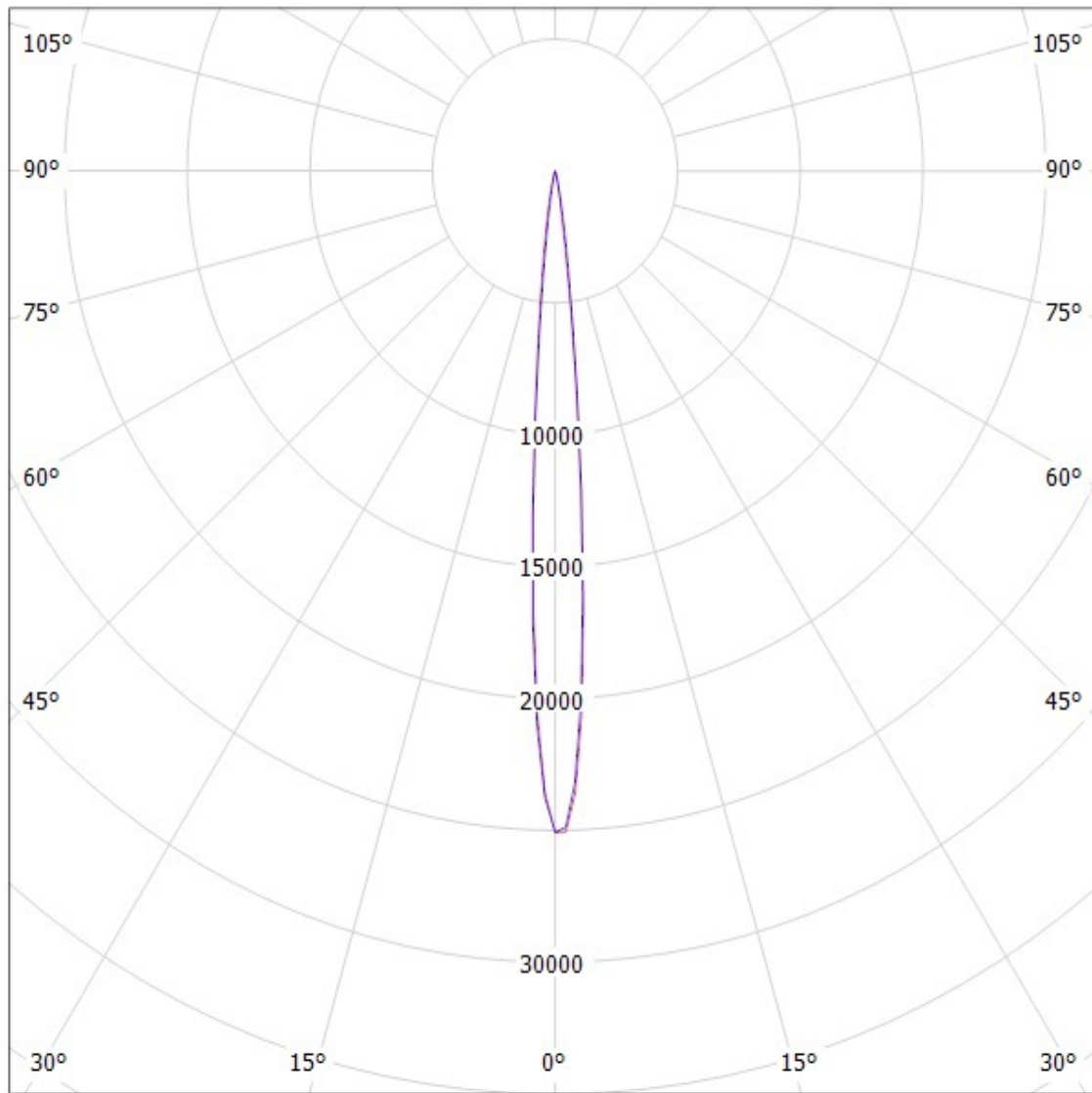

cd/klm

— C0 - C180 — C90 - C270

SIMULATED

Ledil Oy FA10663_LXP-D FA10663_LXP-D / LDC (Polar)

Luminaire: Ledil Oy FA10663_LXP-D FA10663_LXP-D

Lamps: 1 x Cree XP-E (white)

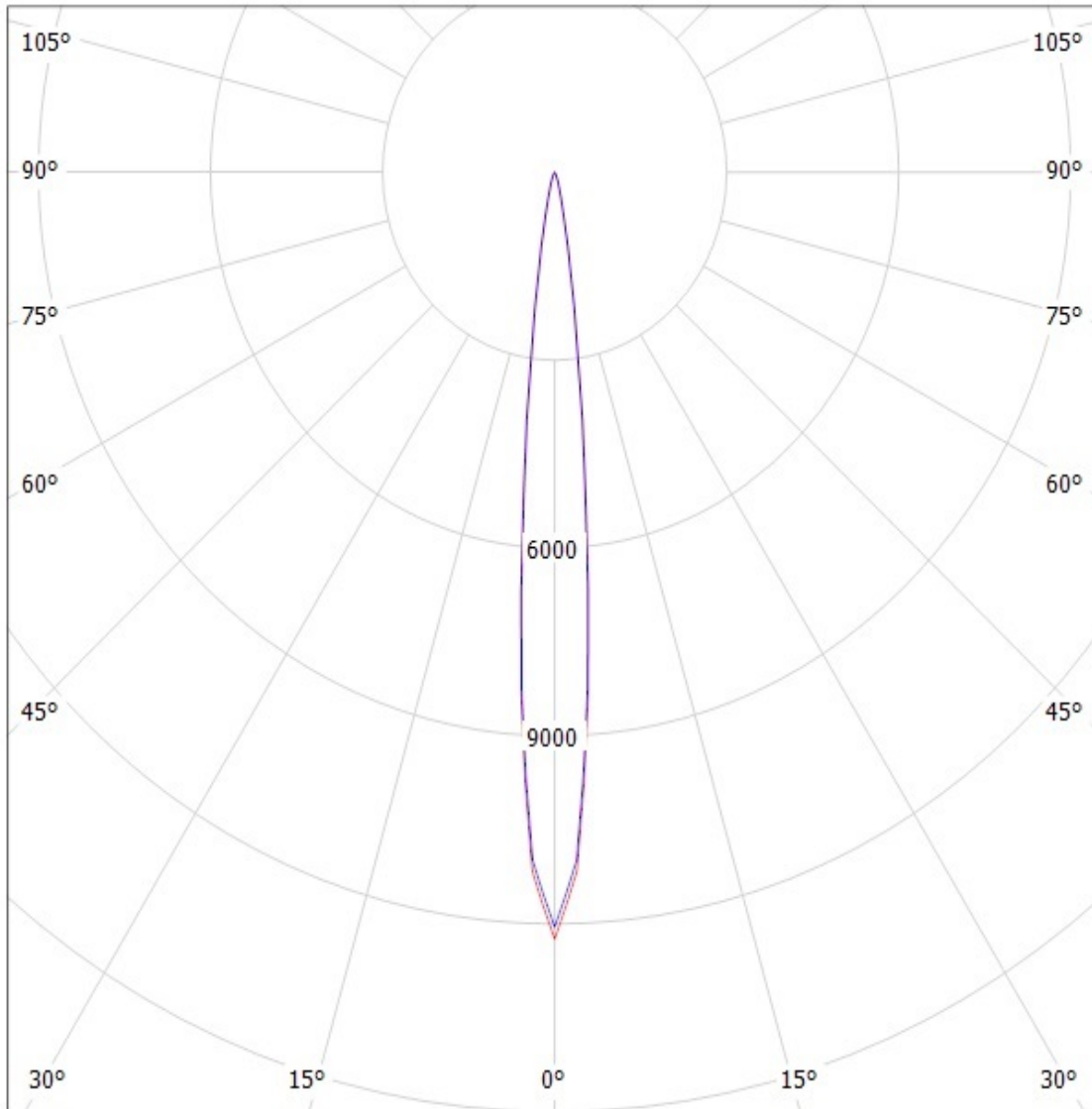

cd/klm

— C0 - C180

— C90 - C270

SIMULATED

Luminaire: Ledil Oy CP11632_LXP3-D-XP-E CP11632_LXP3-D-XP-E
Lamps: 1 x Cree XP-E (White)

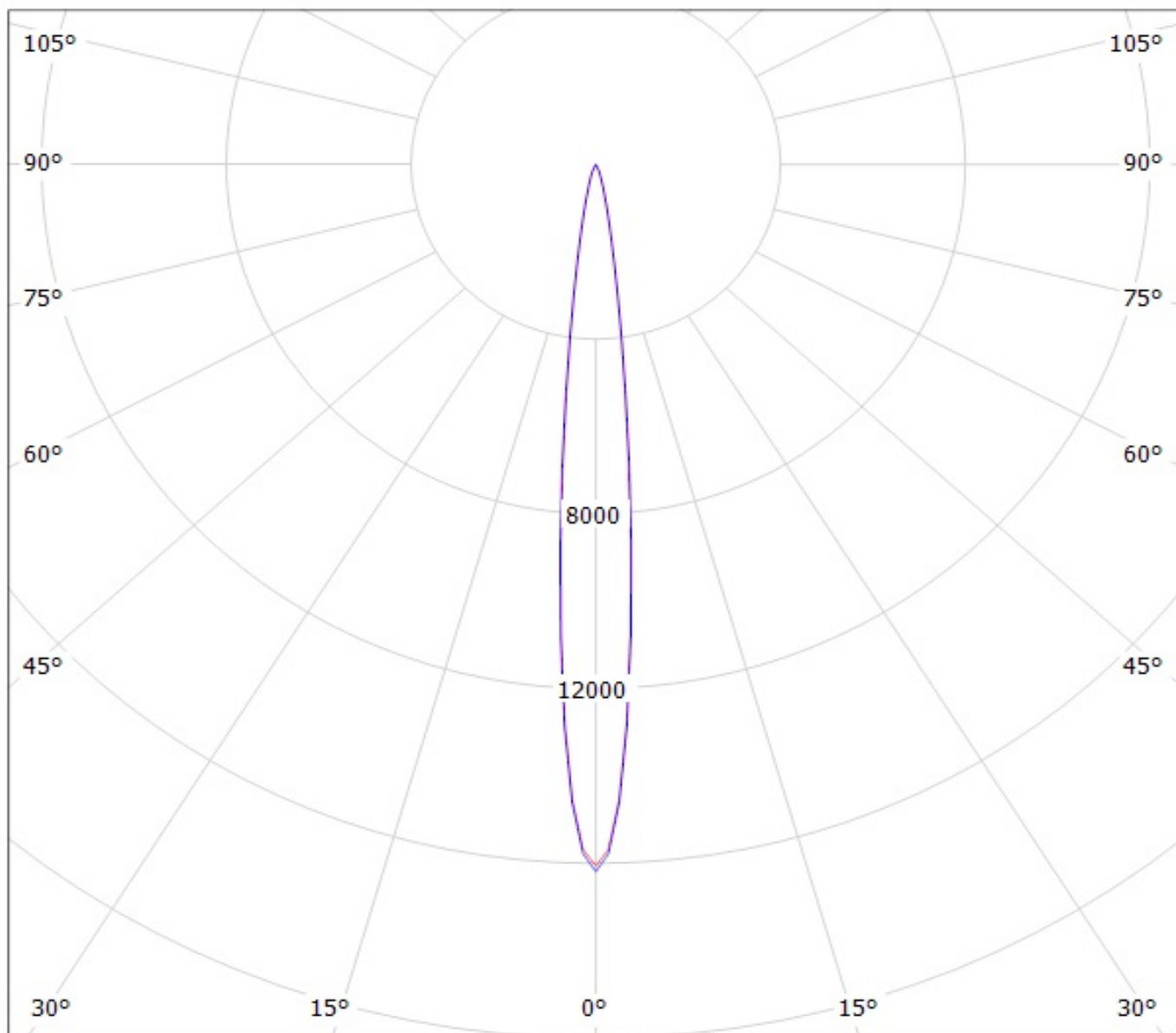

cd/klm

— C0 - C180 — C90 - C270

Ledil Oy FA10660_LXP-M FA10660_LXP-M / LDC (Polar)

Luminaire: Ledil Oy FA10660_LXP-M FA10660_LXP-M

Lamps: 1 x Cree XP-E (White)

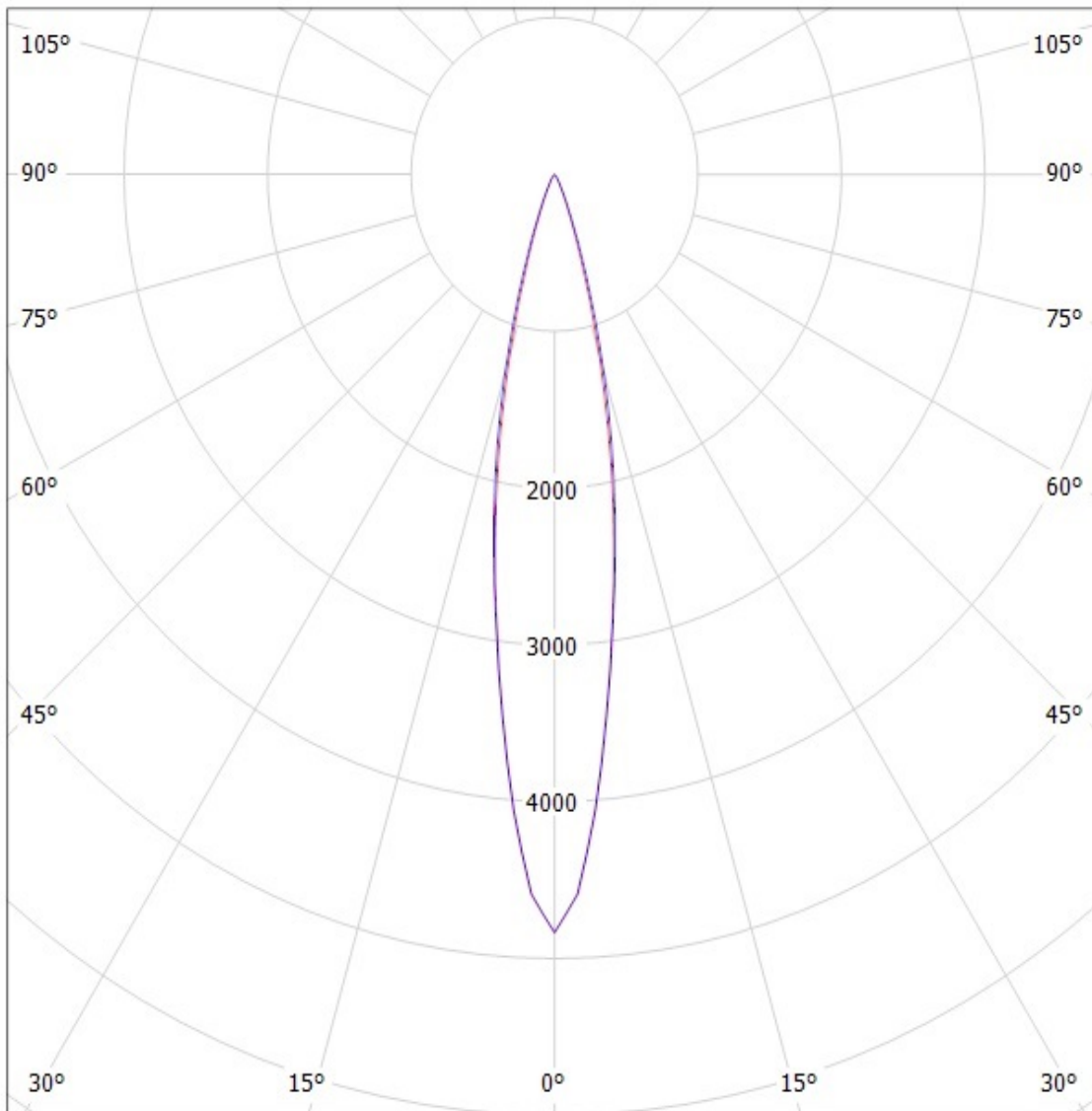

cd/klm

— C0 - C180

— C90 - C270

SIMULATED

Luminaire: Ledil Oy CP11633_LXP3-M-XP-E LOR=93%
Lamps: 1 x Cree XP-E 250mA 77lm

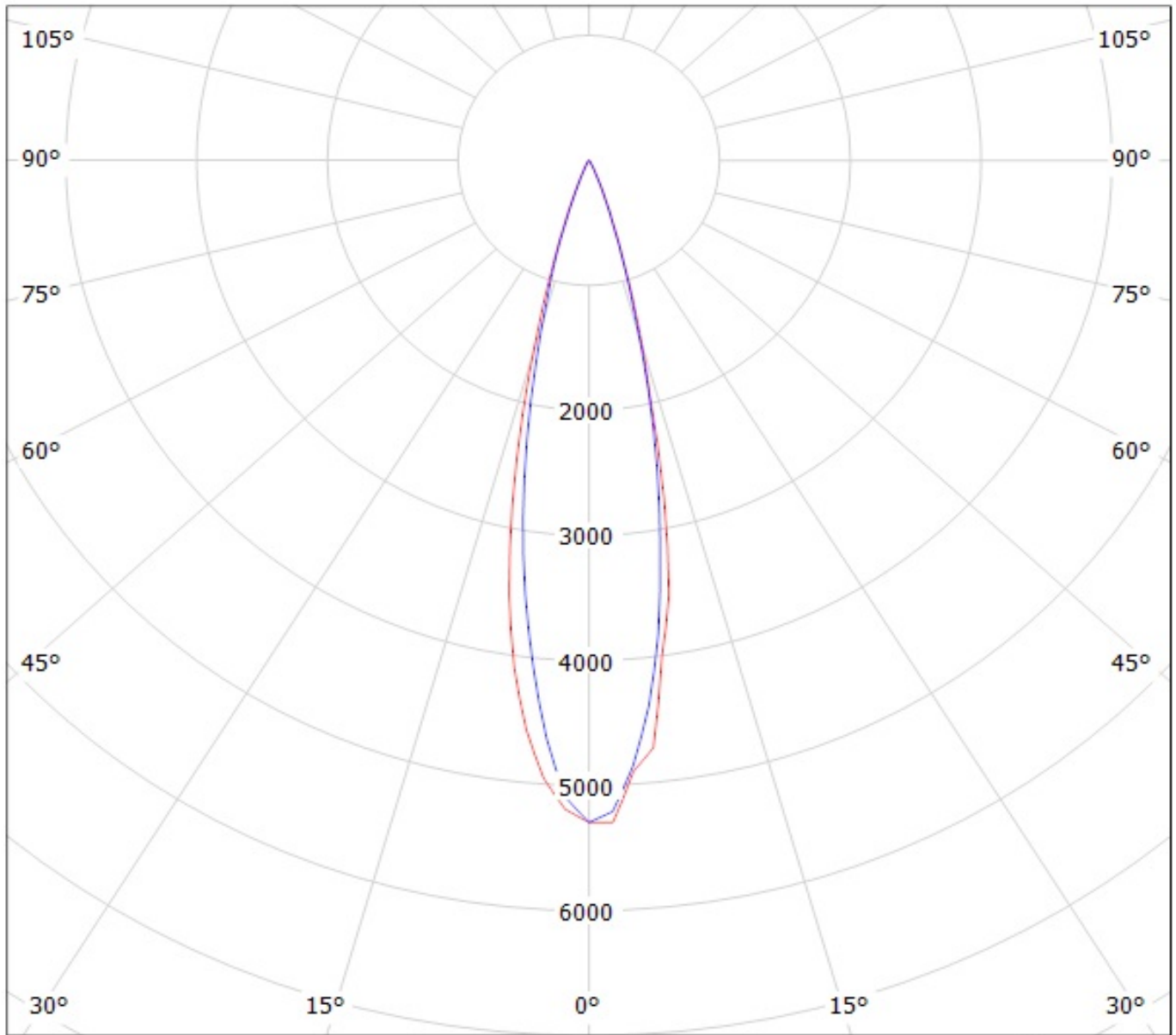

cd/klm

— C0 - C180

— C90 - C270

Luminaire: Ledil Oy FA12218_LXP-O (Cree XP-E 76lm @ 250mA) Efficiency=89%
Lamps: 1 x Cree XP-E 76lm @ 250mA

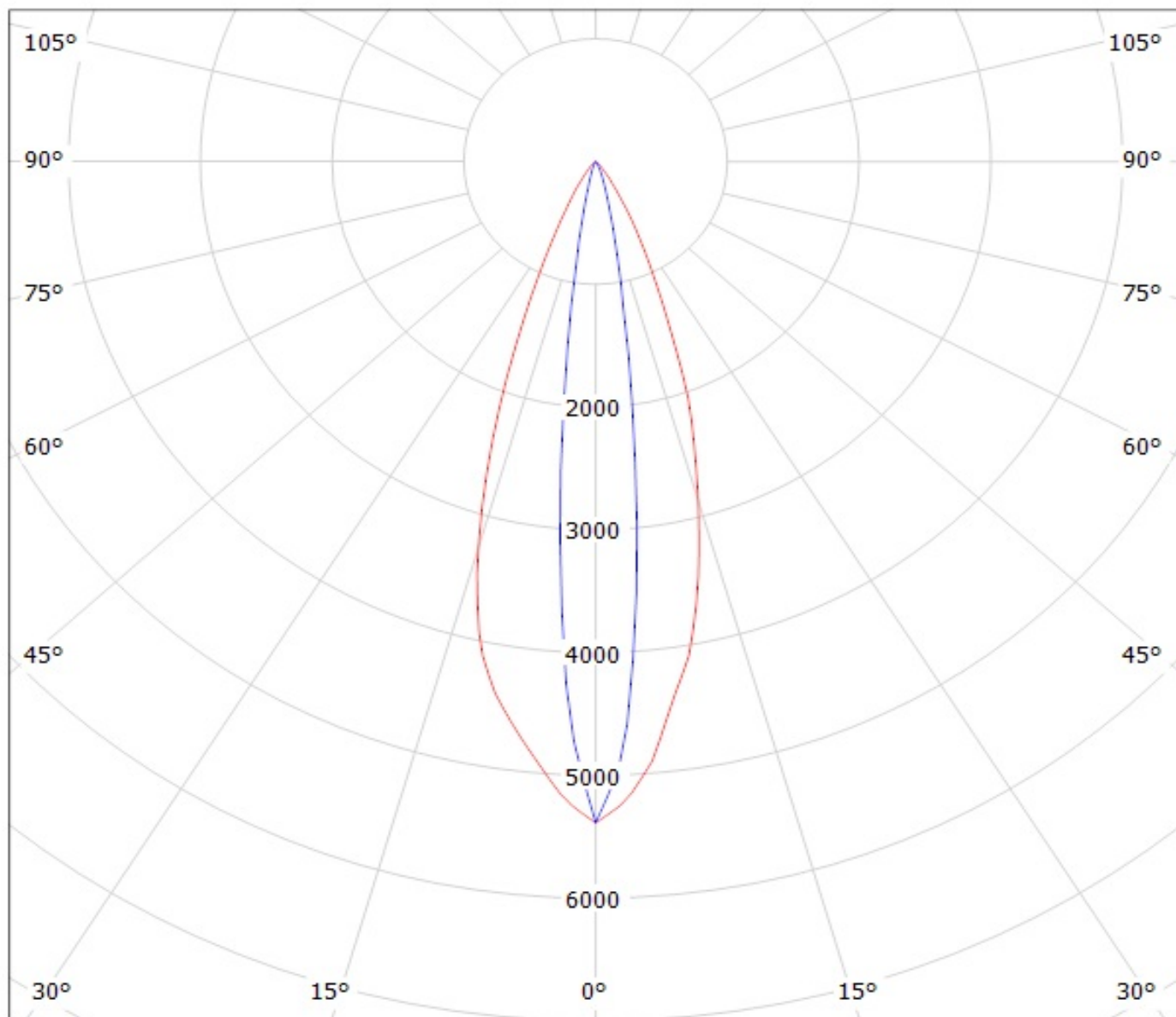

cd/klm

— C0 - C180 — C90 - C270

Luminaire: Ledil Oy FA10662_LXP-REC_(XP-E) Efficiency=82%
Lamps: 1 x FA10662_LXP-REC_(XP-E) 50.36lm @ 250mA CCT=2864K P=0.80W I=250mA

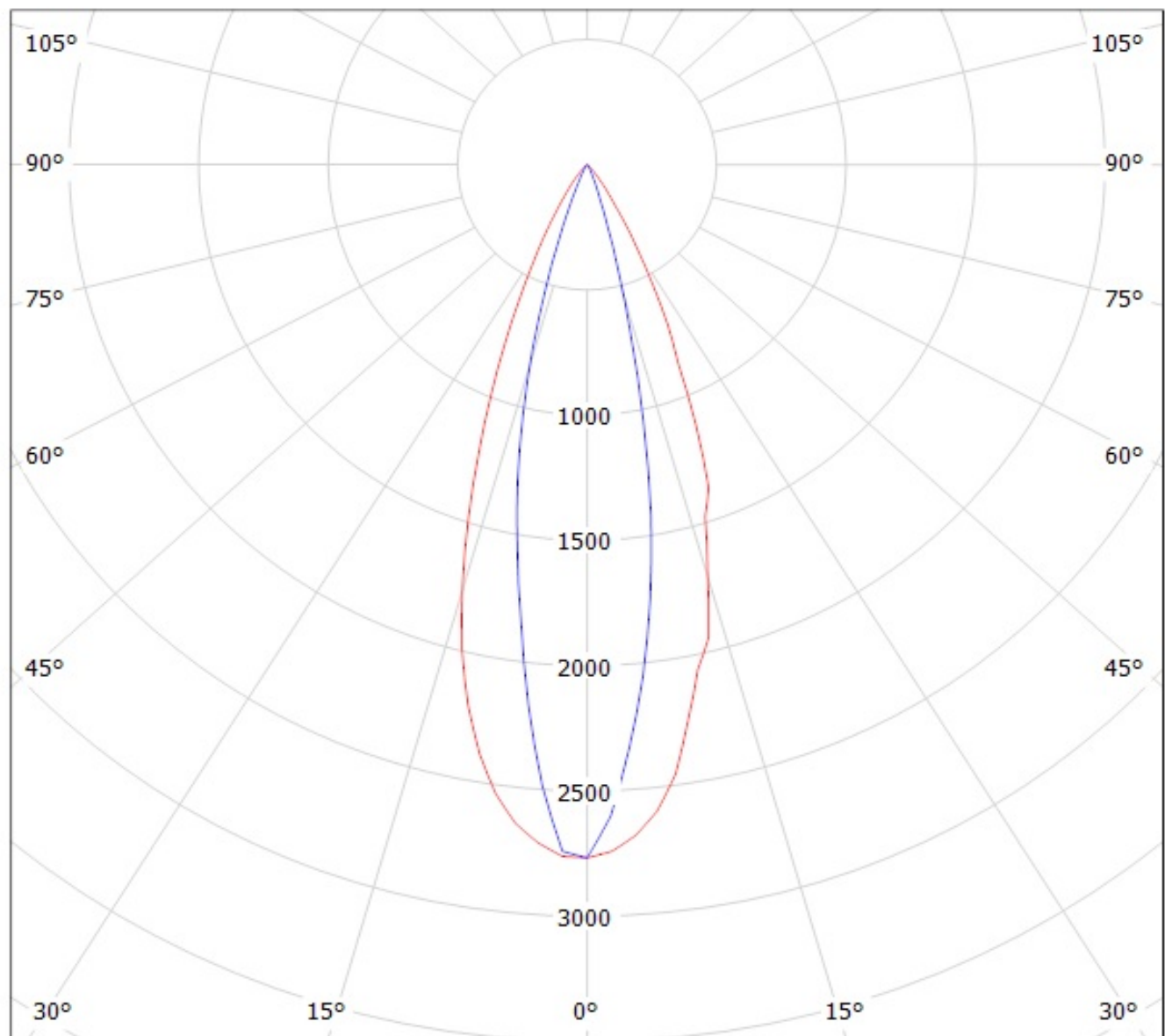

cd/klm
— C0 - C180 — C90 - C270

Ledil Oy FA11116_LXP-O-90 FA11116_LXP-O-90 Cree XP-E LOR=89% / LDC (Polar)

Luminaire: Ledil Oy FA11116_LXP-O-90 FA11116_LXP-O-90 Cree XP-E LOR=89%
Lamps: 1 x Cree XP-E

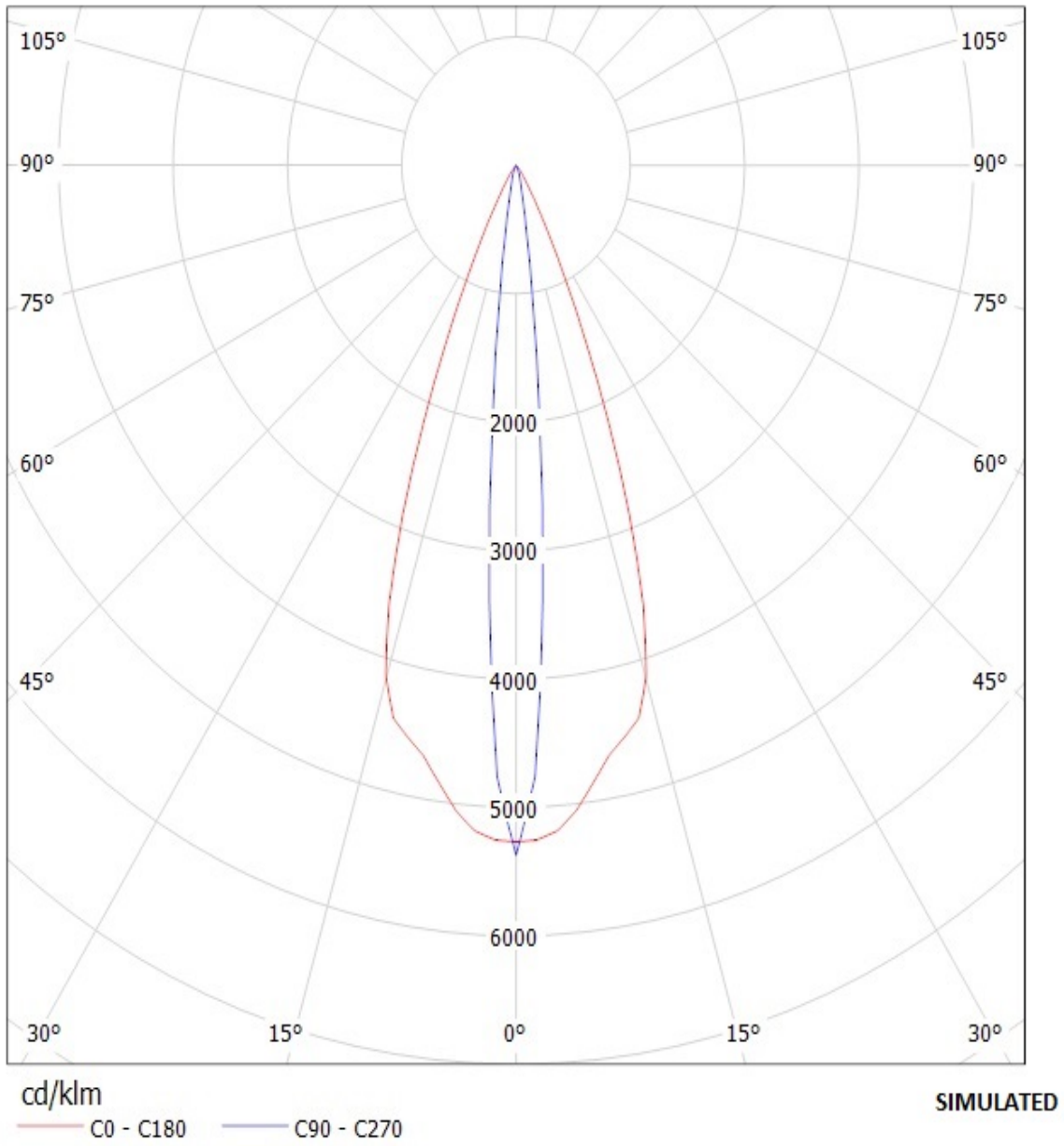

Luminaire: Ledil Oy CP12395_LXP3-W (Cree XP-E 76lm @ 250mA) Efficiency=92%
Lamps: 1 x Cree XP-E 76lm @ 250mA

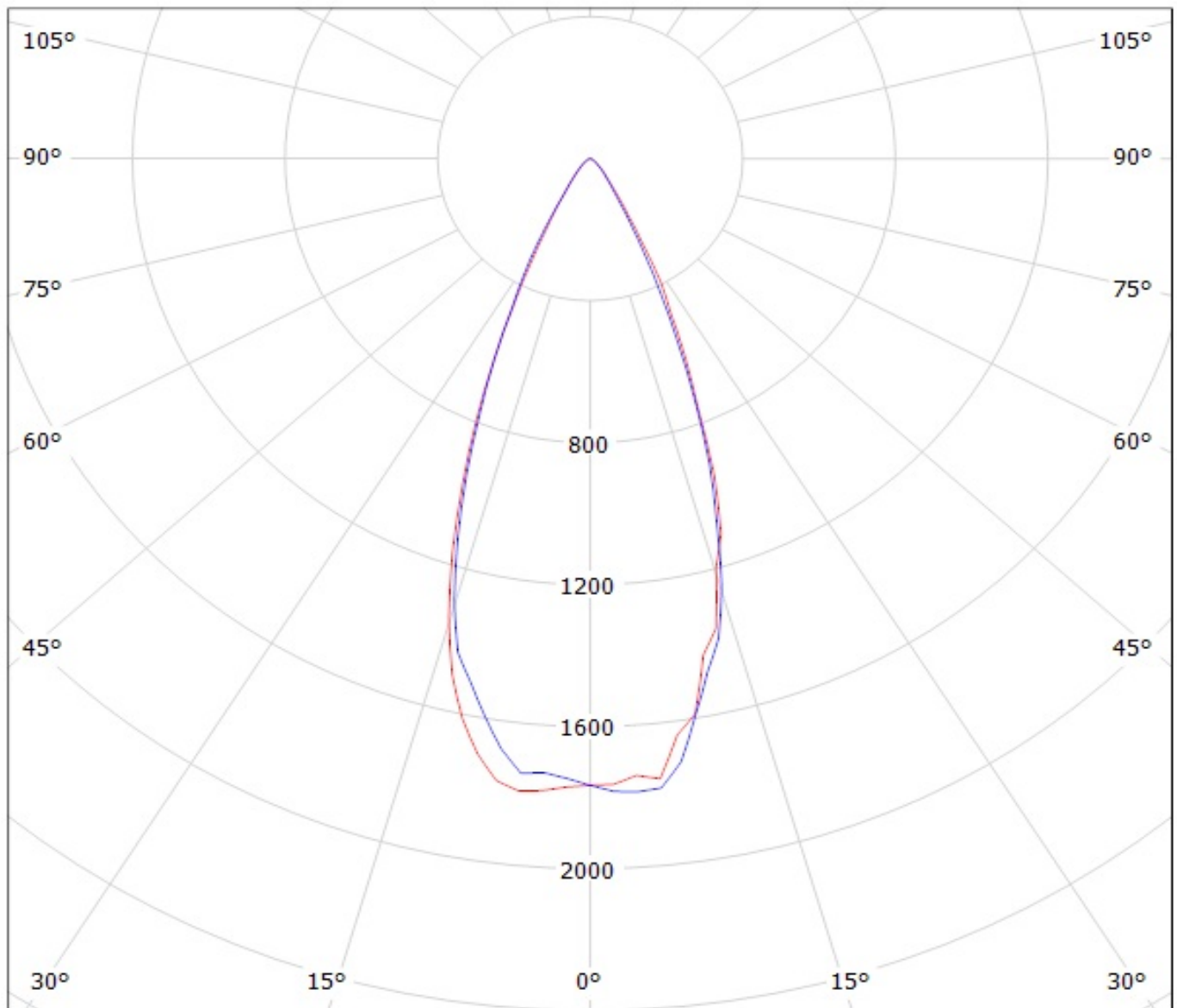

cd/klm

— C0 - C180

— C90 - C270

Luminaire: LEDIL OY FA10832_LXP-W_(XP-E)
Lamps: 1 x XP-E (71.84lm)

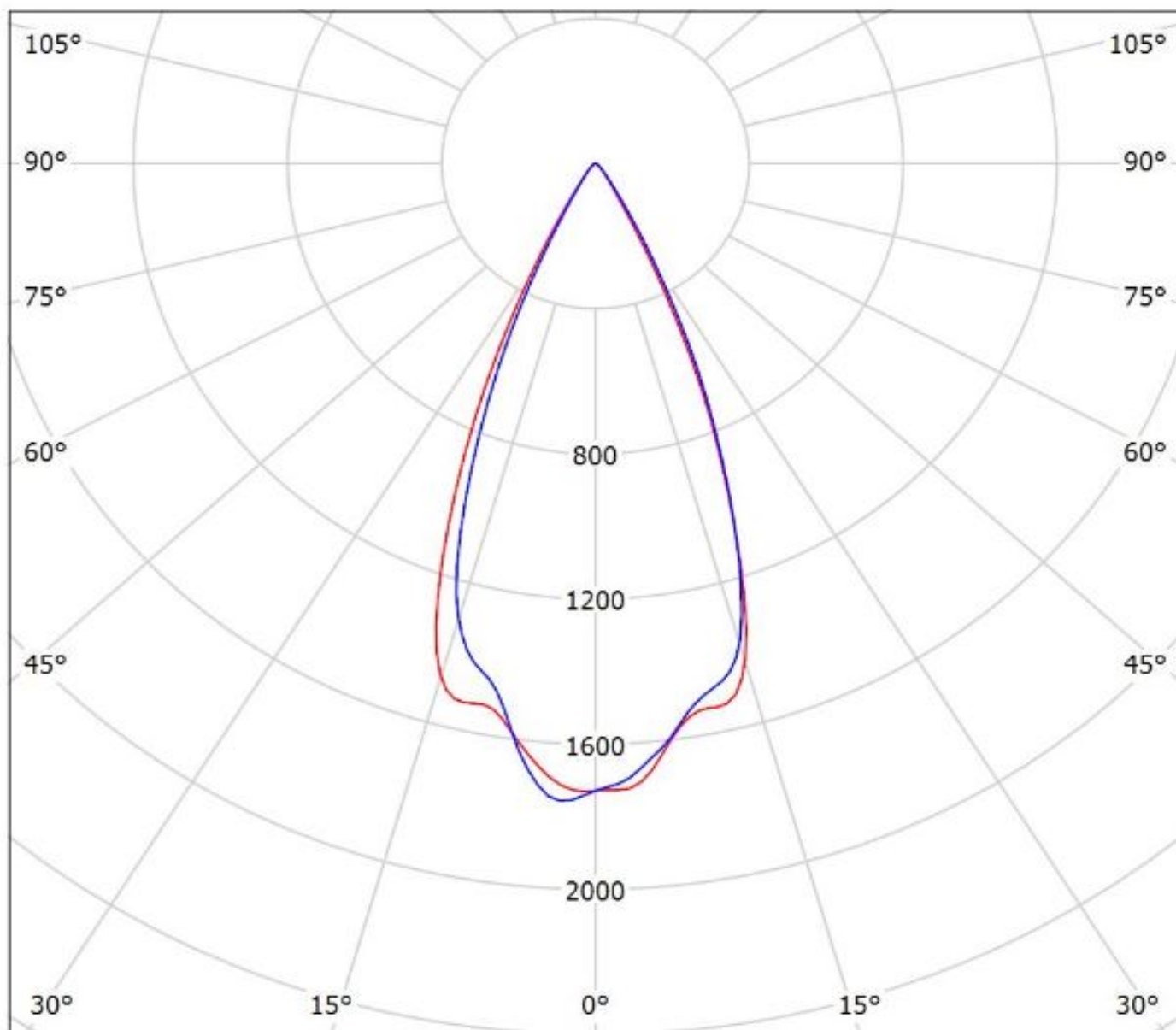

cd/klm

— C0 - C180 — C90 - C270

$\eta = 91\%$

Luminaire: Ledil Oy CA12392_LXP2-W (Cree XP-E 77lm @ 250mA) Efficiency=90%
Lamps: 1 x Cree XP-E 77lm @ 250mA

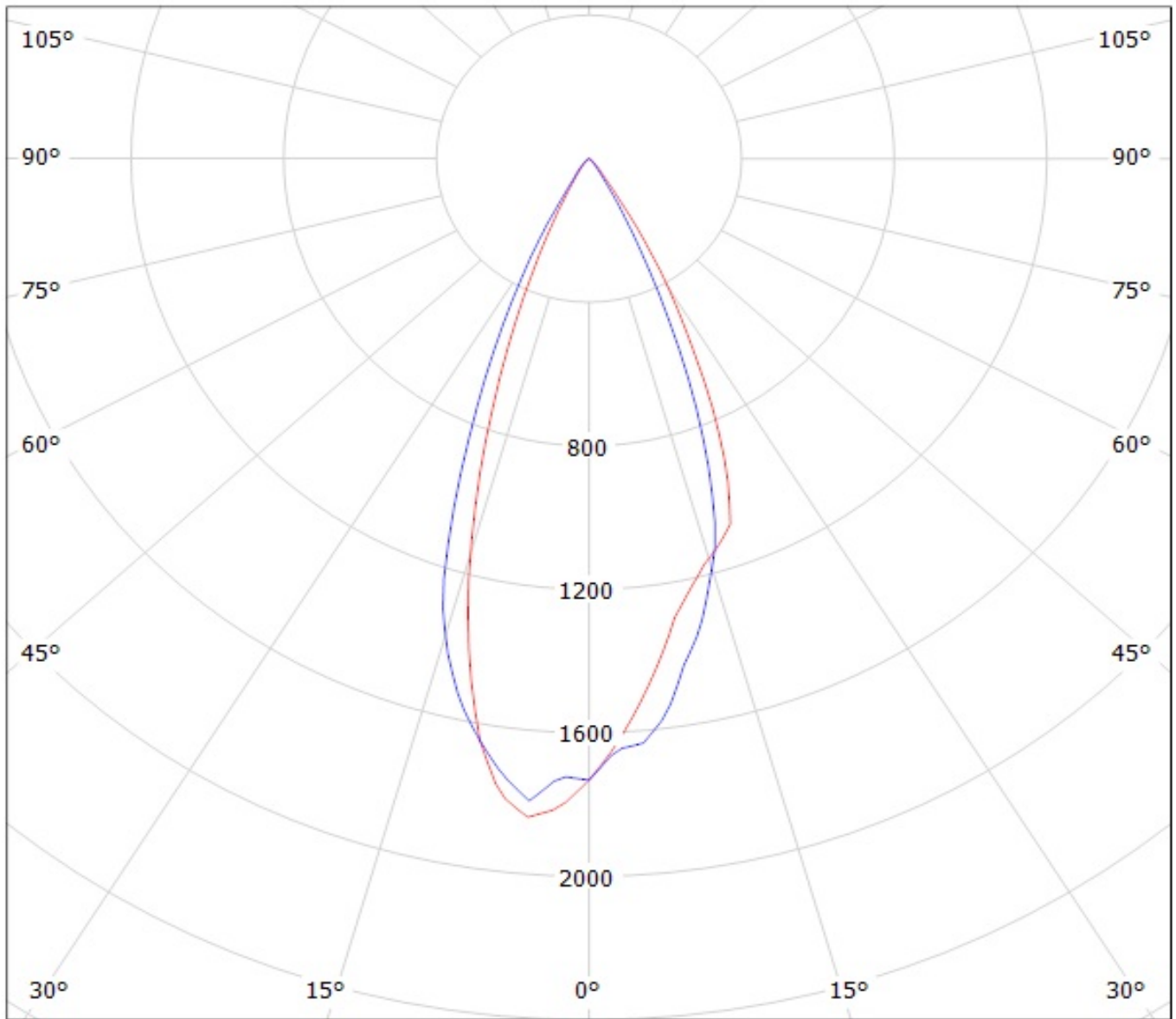

cd/klm

— C0 - C180 — C90 - C270