

DETAILS

| | |
|------------------------|---------------------|
| Product Number | CN12647_LENINA-S-DL |
| Family | Lenina |
| Type | RefPack |
| Color | metal |
| Diameter | 74 mm |
| Height | 47,7 mm |
| Style | round |
| Optic Material | PC |
| Holder Material | |
| Fastening | screw |
| Status | production ready |
| ROHS Compliant | Yes |
| Date Updated | 31/10/2016 |

OPTICAL PROPERTIES

| LED | Viewing | Light | Effi- | | Connector |
|------------------------|---------|-------|--------|-------|-----------|
| | Angle | Beam | ciency | cd/lm | |
| LUXEON CoB 1204/1205 | 19 deg | Spot | 84 % | 3.600 | - |
| LUXEON CoB 1208 | 21 deg | Spot | 85 % | 3.200 | - |
| COB J-Type | 21 deg | Spot | 83 % | 3.060 | - |
| Mega Zenigata (GW5DGC) | 24 deg | Spot | 80 % | 2.800 | - |
| Mega Zenigata (GW6DME) | 21 deg | Spot | 83 % | 3.170 | - |



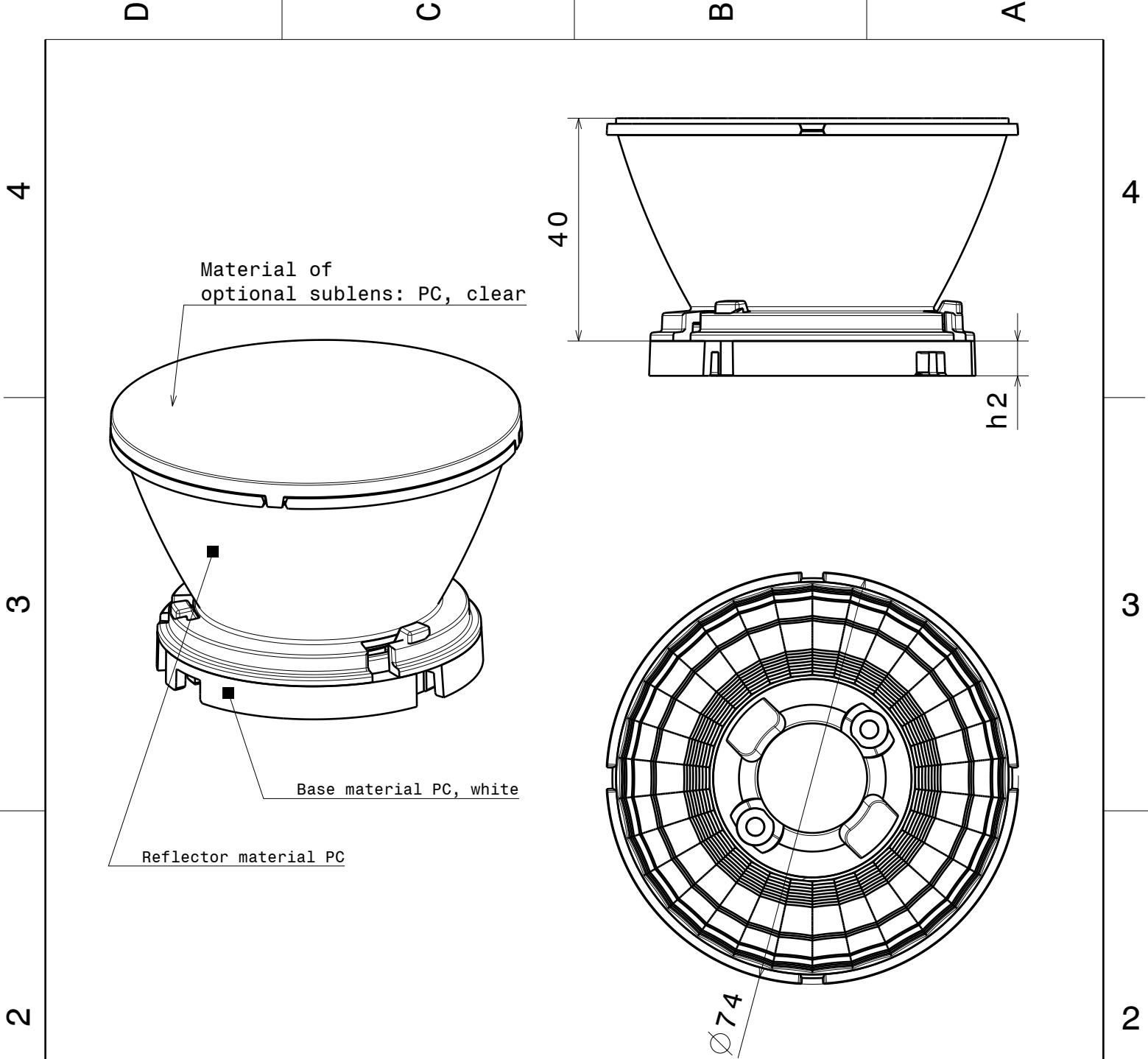

NOTE:

Using optional sublens, add 2.1mm to the system height

Dimension 'h2' varies from 4.5mm to 7mm depending on the LED specific base part

This drawing is our property. It can't be reproduced or communicated without our written agreement.



Ledil Oy
Salorankatu 10
FIN-24240 SALO
Finland

DRAWING TITLE

Datasheet Lenina series

| | | | | | | | | | |
|--------------------------|--|---------------------------|--|-----------------------|--|-----------------------------|--|-----------------------|--|
| DRAWN BY ks | | DATE 23.04.2014 | | SIZE A4 | | DRAWING NUMBER -- | | REV 1 | |
| CHECKED BY | | DATE | | | | | | SHEET 1 / 1 | |
| DESIGNED BY pl | | DATE 08.03.2012 | | SCALE 1 : 1 | | WEIGHT (g) | | | |

Luminaire: LEDiL Oy CN12647_LENINA-S-DL_(LUXEON_CoB_1205) Eff: 84 %
Lamps: 1 x LUXEON CoB 1205 (LHC1-3080-1205) 1106lm@250mA CCT=3000K P=8.3W I=250mA

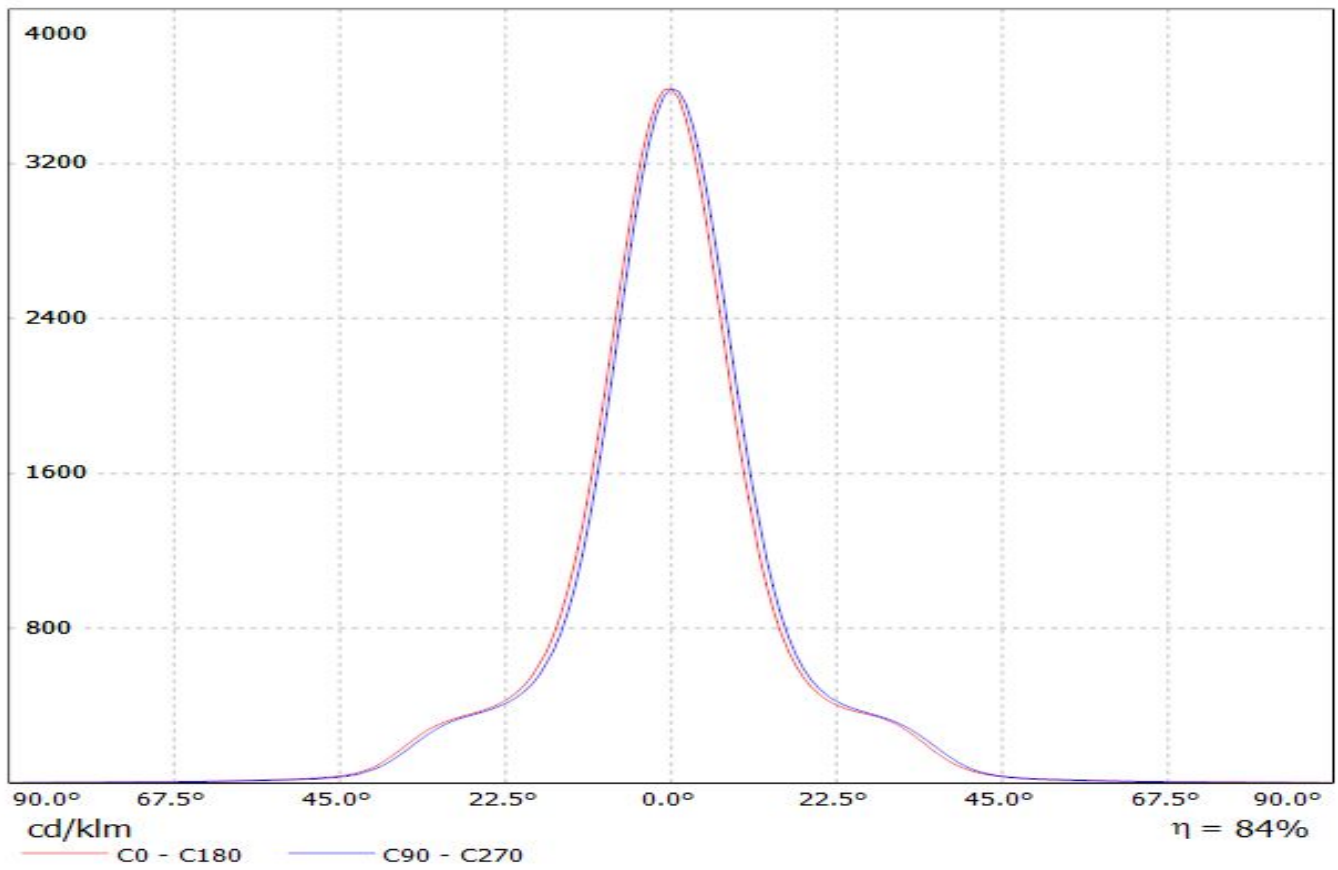

Luminaire: LEDiL Oy CN12647_LENINA-S-DL_(Luxeon_CoB_1208) Eff: 85 %
Lamps: 1 x Luxeon CoB 1208 (LHC1-3080-1208) 1065lm@250mA CCT=3000K P=8.3W I=250mA

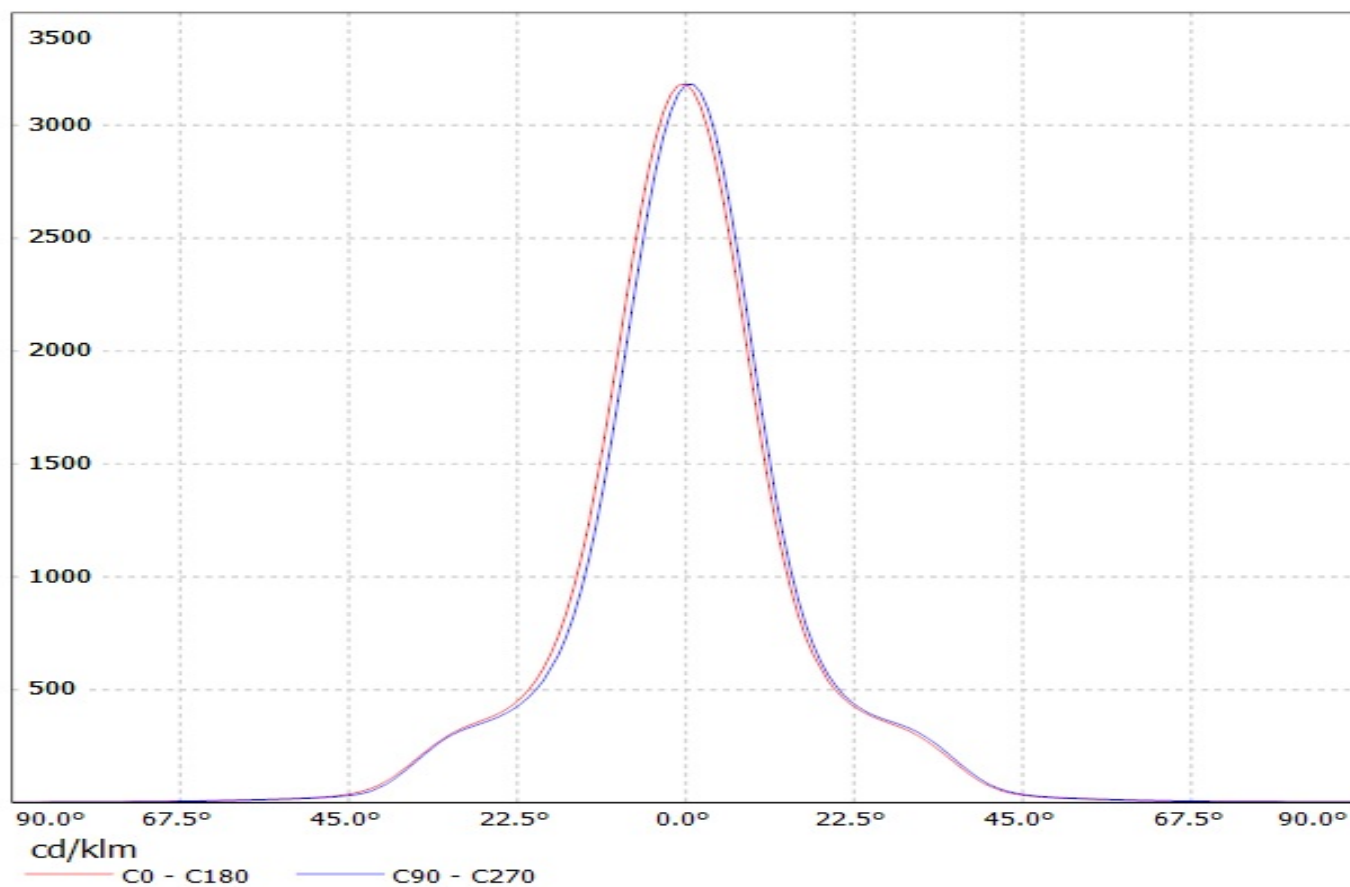

Luminaire: LEDiL Oy CN12647_LENINA-S-DL_(NSCxJ216A) Eff.82.9%
Lamps: 1 x NICHIA_NSCxJ216A_(NSCLJ216AE)_1073.33lm@250mA CCT=3000K P=8.11575W I=249.9mA

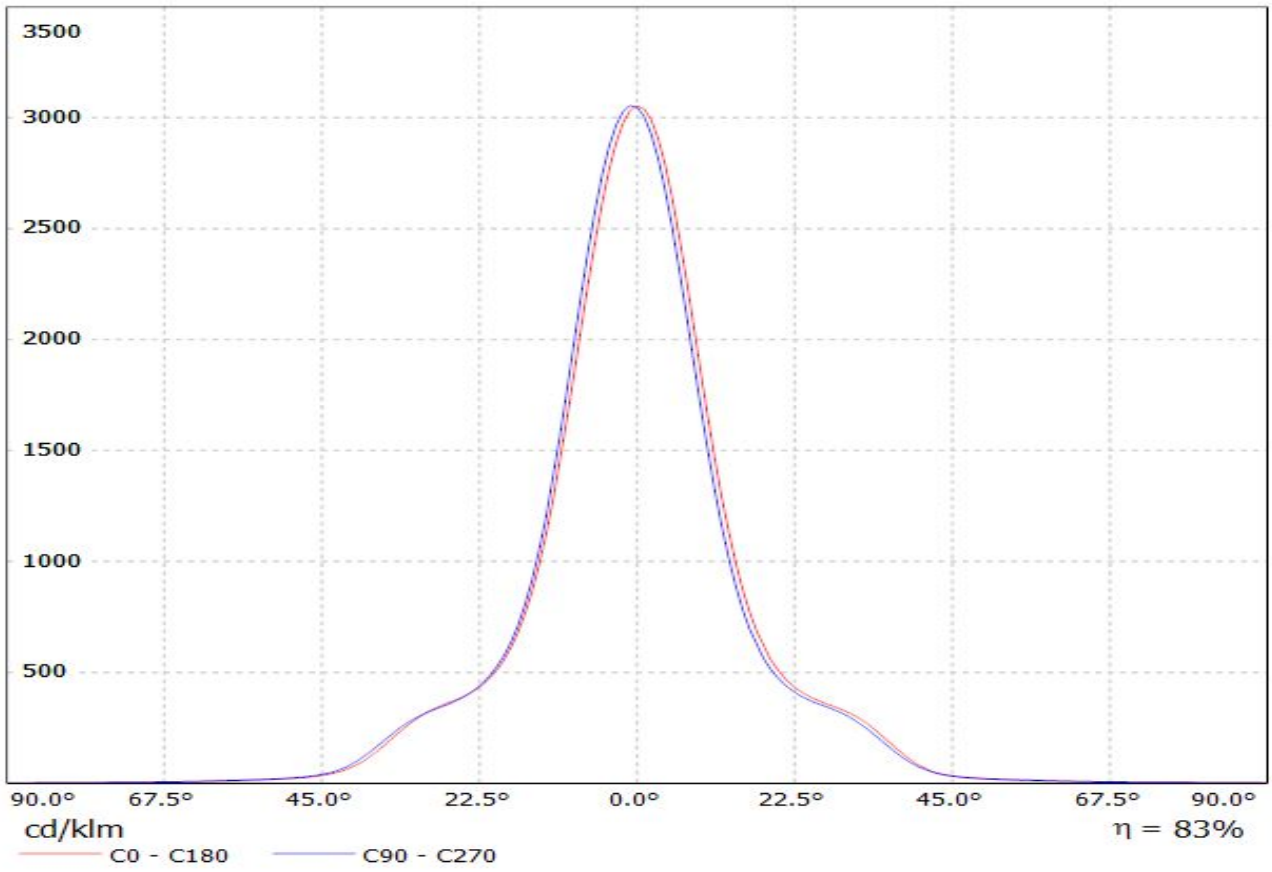

Luminaire: Ledil Oy CN12647_LENINA-S-DL (Megazenigata 867lm @ 250mA) Efficiency=82%
Lamps: 1 x Megazenigata 867lm @ 250mA

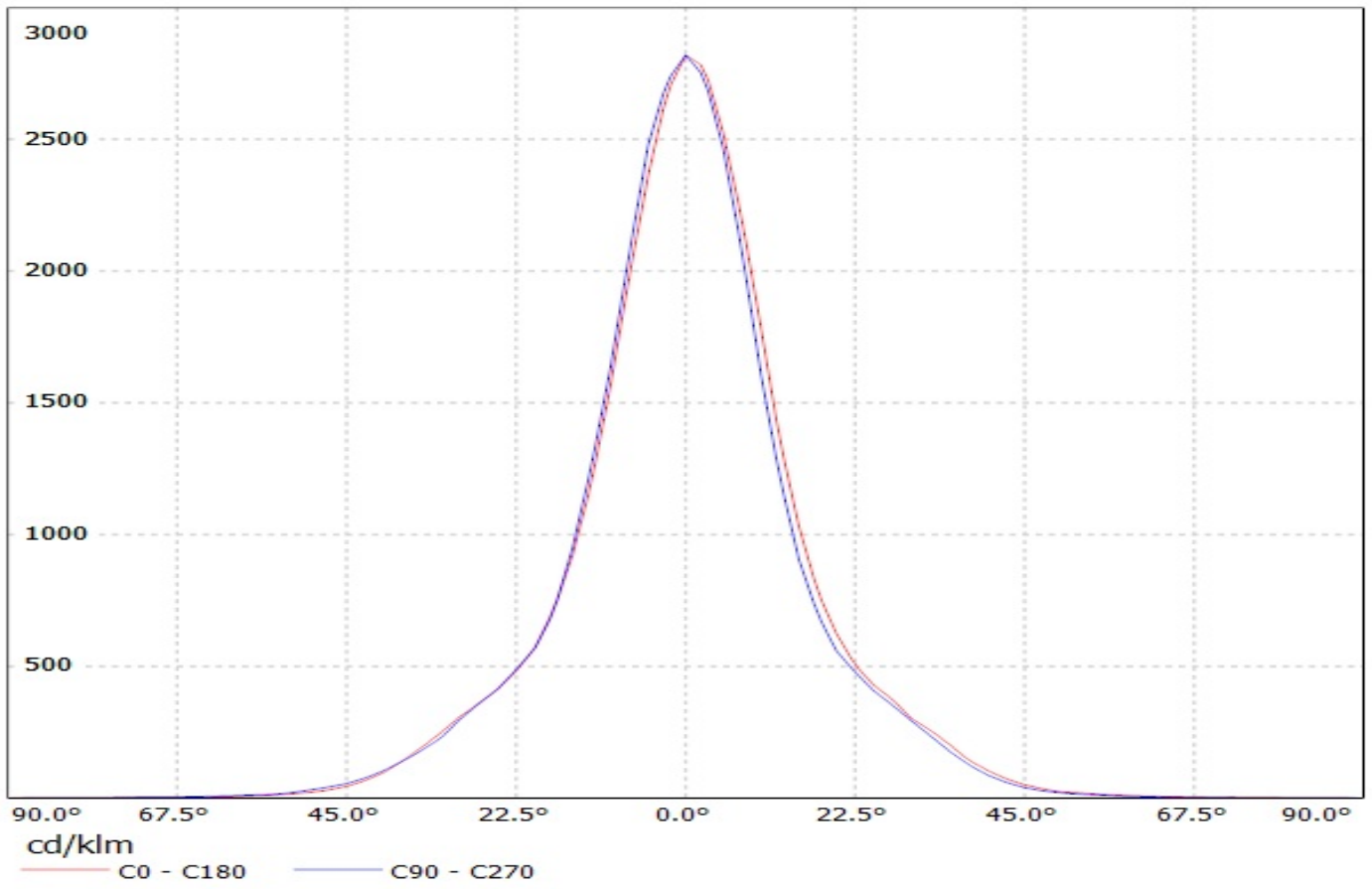

Luminaire: LEDiL Oy CN12647_LENINA-S-DL_(Megazenigata_GW6D) Eff.83.1%
Lamps: 1 x SHARP_Megazenigata_(GW6DMC40NFC)_1087.39lm@250mA_P=8.48721W_I=249.8mA

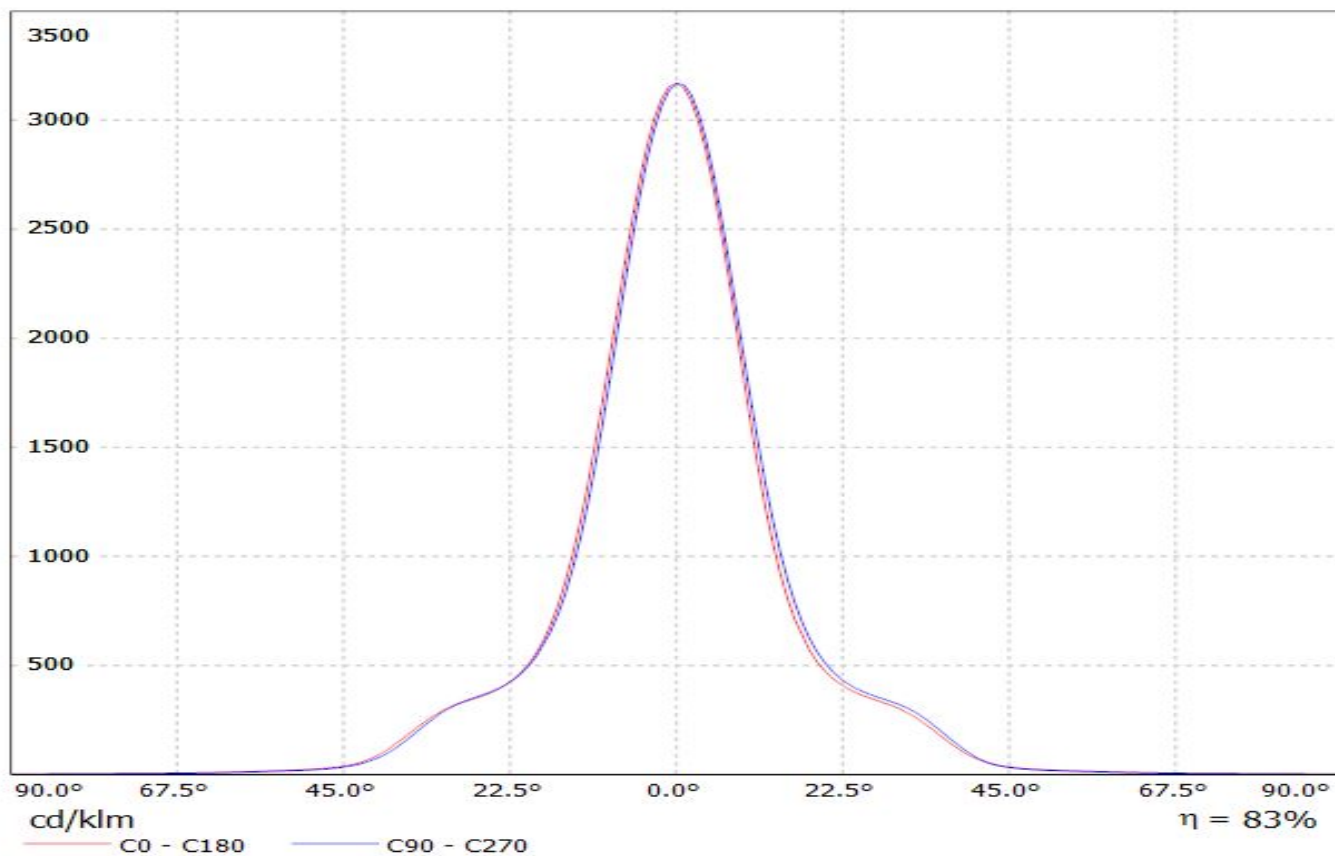

Luminaire: LEDiL Oy CN12647_LENINA-S-DL_(LUXEON_CoB_1205) Eff. 84 %
Lamps: 1 x LUXEON CoB 1205 (LHC1-3080-1205) 1106lm@250mA CCT=3000K P=8.3W I=250mA

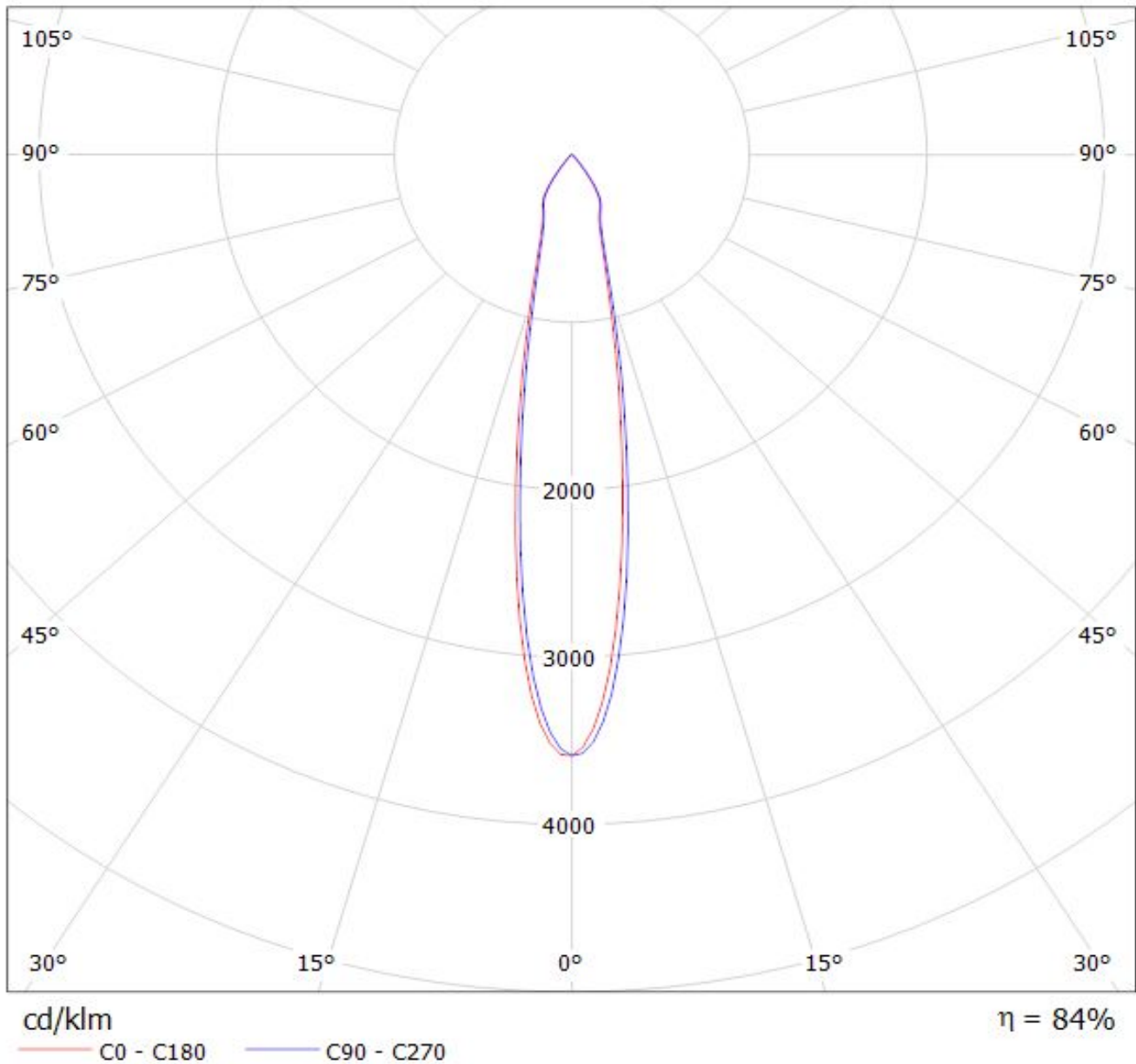

Luminaire: LEDiL Oy CN12647_LENINA-S-DL_(Luxeon_CoB_1208) Eff. 85 %
Lamps: 1 x Luxeon CoB 1208 (LHC1-3080-1208) 1065lm@250mA CCT=3000K P=8.3W I=250mA

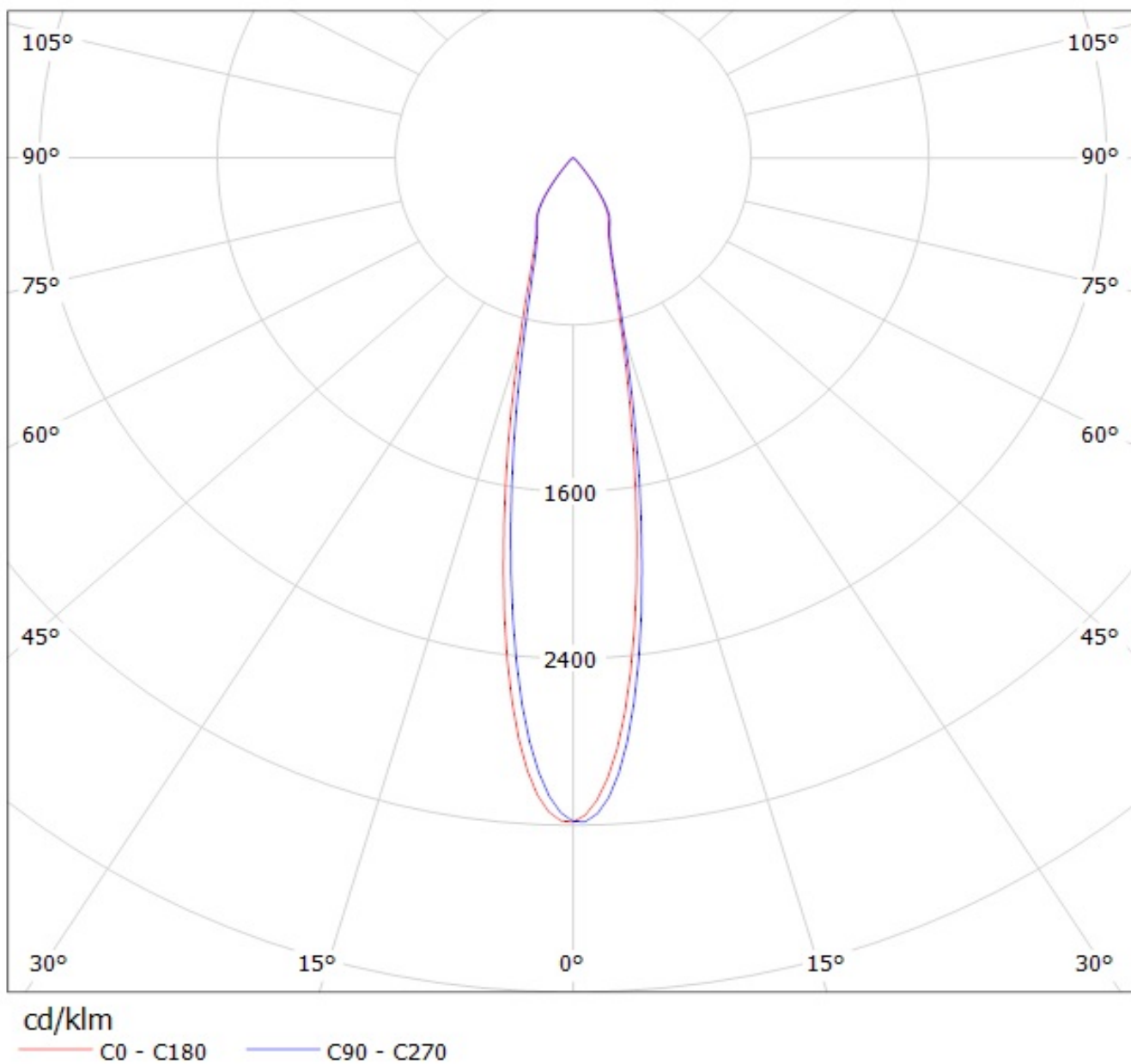

Luminaire: LEDiL Oy CN12647_LENINA-S-DL_(NSCxJ216A) Eff.82.9%
Lamps: 1 x NICHIA_NSCxJ216A_(NSCLJ216AE)_1073.33lm@250mA CCT=3000K P=8.11575W I=249.9mA

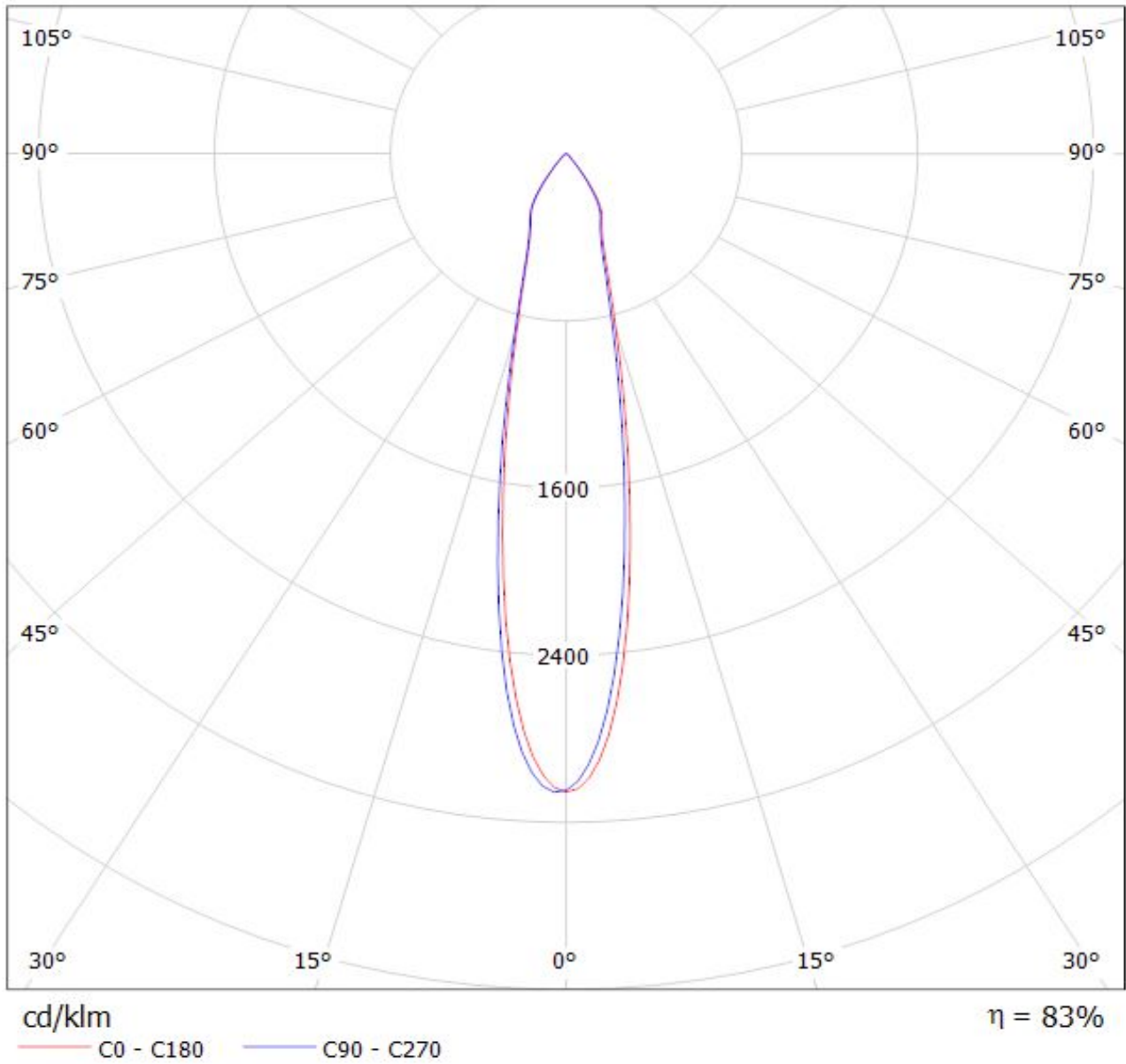

Luminaire: Ledil Oy CN12647_LENINA-S-DL (Megazenigata 867lm @ 250mA) Efficiency=82%
Lamps: 1 x Megazenigata 867lm @ 250mA

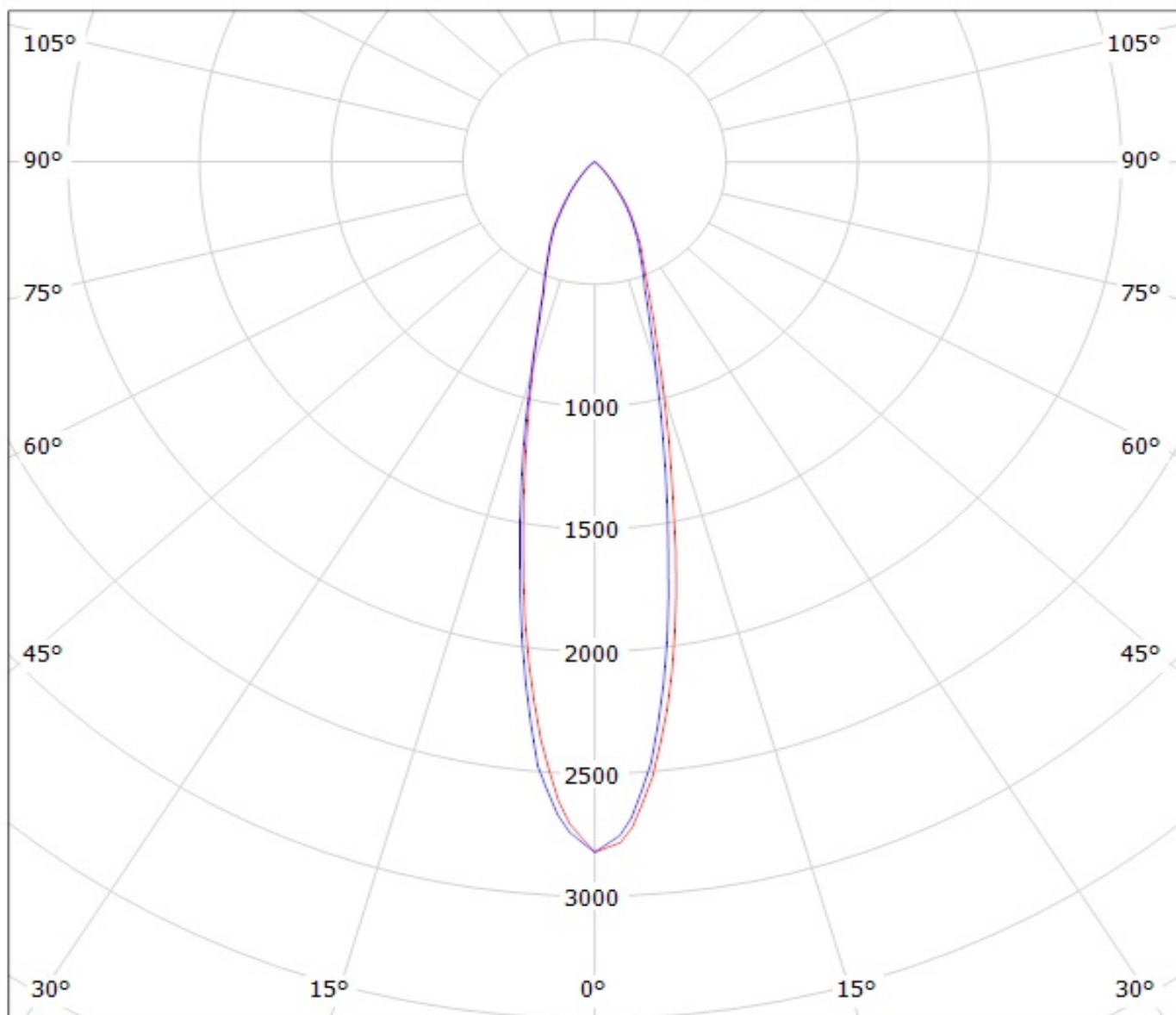

cd/klm

— C0 - C180

— C90 - C270

Luminaire: LEDiL Oy CN12647_LENINA-S-DL_(Megazenigata_GW6D) Eff.83.1%

Lamps: 1 x SHARP_Megazenigata_(GW6DMC40NFC)_1087.39lm@250mA_P=8.48721W_I=249.8mA

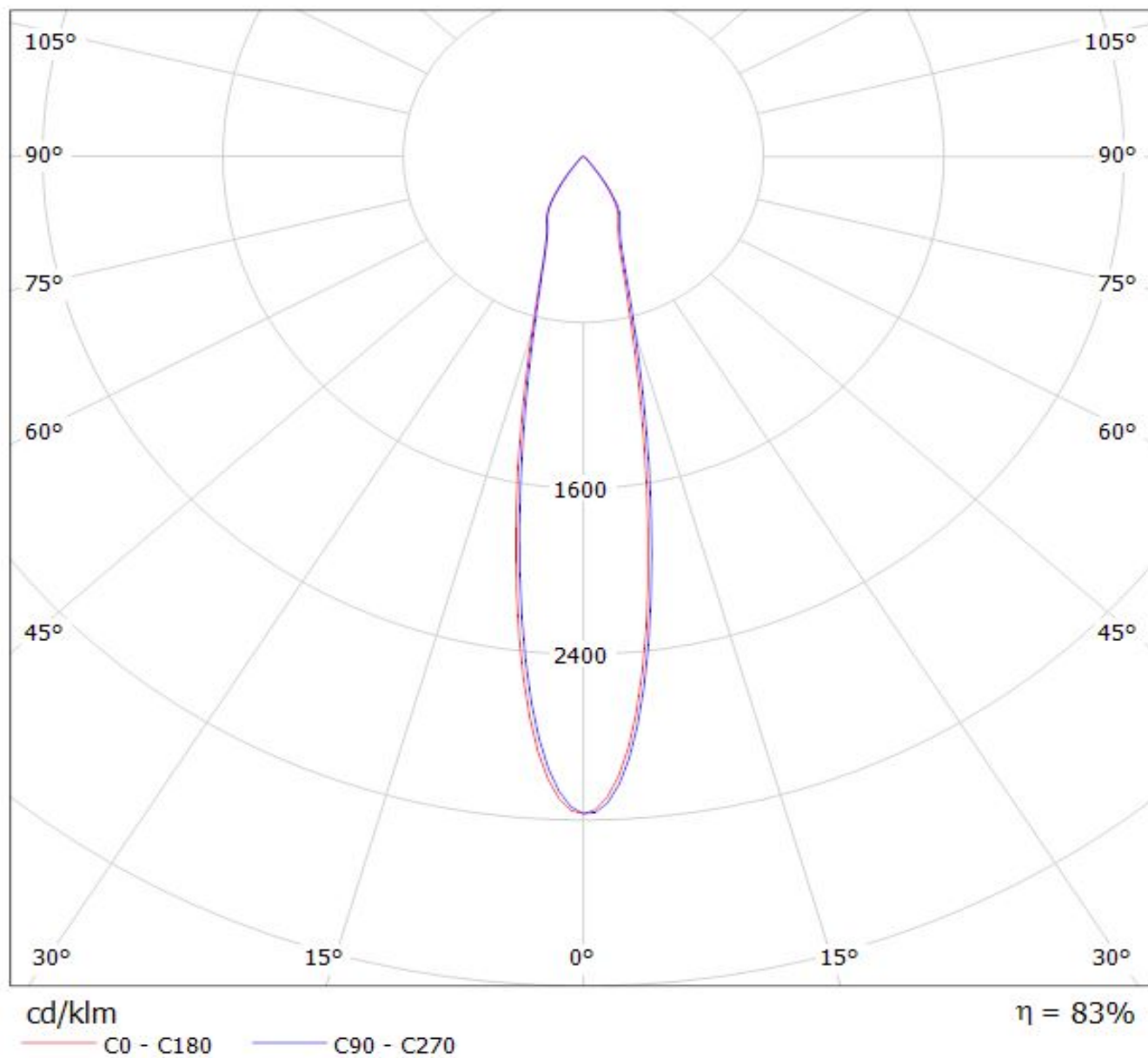

NOTE: The typical divergence will be changed by different color, chip size and chip position tolerance. The typical total divergence is the full angle measured where the luminous intensity is half of the peak value.

GENERAL INFORMATION

- Product series especially designed & optimized for series of LEDs.
- Special care taken to make light distribution as uniform as possible.

Note! Due to use of high power COB's with this product, special attention to proper thermal design is highly recommended. LEDiL has no liability for direct, indirect or consecutive damages arising from the LEDiL products being used outside of the recommended temperature range.